

# **700G Series**

## Pressure Gauges

### Users Manual

## LIMITED WARRANTY AND LIMITATION OF LIABILITY

Each Fluke product is warranted to be free from defects in material and workmanship under normal use and service. The warranty period is two years and begins on the date of shipment. Parts, product repairs, and services are warranted for 90 days. This warranty extends only to the original buyer or end-user customer of a Fluke authorized reseller, and does not apply to fuses, disposable batteries, or to any product which, in Fluke's opinion, has been misused, altered, neglected, contaminated, or damaged by accident or abnormal conditions of operation or handling. Fluke warrants that software will operate substantially in accordance with its functional specifications for 90 days and that it has been properly recorded on non-defective media. Fluke does not warrant that software will be error free or operate without interruption.

Fluke authorized resellers shall extend this warranty on new and unused products to end-user customers only but have no authority to extend a greater or different warranty on behalf of Fluke. Warranty support is available only if product is purchased through a Fluke authorized sales outlet or Buyer has paid the applicable international price. Fluke reserves the right to invoice Buyer for importation costs of repair/replacement parts when product purchased in one country is submitted for repair in another country.

Fluke's warranty obligation is limited, at Fluke's option, to refund of the purchase price, free of charge repair, or replacement of a defective product which is returned to a Fluke authorized service center within the warranty period.

To obtain warranty service, contact your nearest Fluke authorized service center to obtain return authorization information, then send the product to that service center, with a description of the difficulty, postage and insurance prepaid (FOB Destination). Fluke assumes no risk for damage in transit. Following warranty repair, the product will be returned to Buyer, transportation prepaid (FOB Destination). If Fluke determines that failure was caused by neglect, misuse, contamination, alteration, accident, or abnormal condition of operation or handling, including overvoltage failures caused by use outside the product's specified rating, or normal wear and tear of mechanical components, Fluke will provide an estimate of repair costs and obtain authorization before commencing the work. Following repair, the product will be returned to the Buyer transportation prepaid and the Buyer will be billed for the repair and return transportation charges (FOB Shipping Point).

THIS WARRANTY IS BUYER'S SOLE AND EXCLUSIVE REMEDY AND IS IN LIEU OF ALL OTHER WARRANTIES, EXPRESS OR IMPLIED, INCLUDING BUT NOT LIMITED TO ANY IMPLIED WARRANTY OF MERCHANTABILITY OR FITNESS FOR A PARTICULAR PURPOSE. FLUKE SHALL NOT BE LIABLE FOR ANY SPECIAL, INDIRECT, INCIDENTAL OR CONSEQUENTIAL DAMAGES OR LOSSES, INCLUDING LOSS OF DATA, ARISING FROM ANY CAUSE OR THEORY.

Since some countries or states do not allow limitation of the term of an implied warranty, or exclusion or limitation of incidental or consequential damages, the limitations and exclusions of this warranty may not apply to every buyer. If any provision of this Warranty is held invalid or unenforceable by a court or other decision-maker of competent jurisdiction, such holding will not affect the validity or enforceability of any other provision.

Fluke Corporation  
P.O. Box 9090  
Everett, WA 98206-9090  
U.S.A.

Fluke Europe B.V.  
P.O. Box 1186  
5602 BD Eindhoven  
The Netherlands

ООО «Флюк СИАЙЭС»  
125167, г. Москва,  
Ленинградский проспект дом 37,  
корпус 9, подъезд 4, 1 этаж

# Table of Contents

Title	Page
Introduction.....	1
How to Contact Fluke .....	1
Safety Information .....	2
Ex-Hazardous Areas .....	4
Display and Buttons.....	4
Control Panel.....	5
Basic Operation .....	5
Setup the Product.....	6
Set Tare .....	7
Supervisory Mode .....	7
Set Custom Unit/Scale.....	7
Maintenance .....	8
Clean the Product .....	8
Batteries.....	8
RS-232 Interface .....	10
Specifications .....	10



## ***Introduction***

The 700G Series Pressure Gauges (the Product) are high-accuracy digital pressure test gauges. Accurate to 0.05 % Full Scale, the Products can be used as a calibration reference, or in any application where high-accuracy pressure measurement is required.

The Product has user-configurable functions that include:

- Sample rate
- Tare
- Damper
- Auto off
- Units selection
- Max/Min

The Product includes password protect to lock and unlock the functions.

The Product ships with a Protective Cover, three AA Batteries (installed), and an NPT/metric Adapter.

## ***How to Contact Fluke***

To contact Fluke, call one of the following telephone numbers:

- Technical Support USA: 1-800-44-FLUKE (1-800-443-5853)
- Calibration/Repair USA: 1-888-99-FLUKE (1-888-993-5853)
- Canada: 1-800-36-FLUKE (1-800-363-5853)
- Europe: +31 402-675-200
- Japan: +81-3-6714-3114
- Singapore: +65- 6799- 5566
- China: +86-400-921-0835
- Anywhere in the world: +1-425-446-5500

Or, visit Fluke's website at [www.fluke.com](http://www.fluke.com).

To register your product, visit <http://register.fluke.com>.

To view, print, or download the latest manual supplement, visit <http://us.fluke.com/usen/support/manuals>.

## **Safety Information**

A **Warning** identifies conditions and procedures that are dangerous to the user. A **Caution** identifies conditions and procedures that can cause damage to the Product or the equipment under test.

### **⚠ Warning**

To prevent possible fire, explosion, or personal injury:

- Read all safety information before you use the Product.
- Carefully read all instructions.
- Do not alter the Product and use only as specified, or the protection supplied by the Product can be compromised.
- Do not use the Product if it operates incorrectly.
- Do not use the Product if it is altered or damaged.
- Disable the Product if it is damaged.
- Avoid any action that can generate an electrostatic charge. Electrostatic discharge is an explosion hazard.
- Clean the Product only with a damp cloth.
- Do not rub the non-metallic parts of the enclosure (display overlay or holster) with a dry cloth. This action can create an electrostatic discharge.
- Only assemble and operate high-pressure systems if you know the correct safety procedures. High-pressure liquids and gases are hazardous and the energy from them can be released without warning.
- Do not use the RS-232 interface in hazardous areas. The RS-232 interface port must be sealed when used in a hazardous area.
- Substitution of components can impair suitability for hazardous locations.
- If the Product is exposed to overpressure or sudden physical shock (such as a drop), examine the Product for damage that can cause a safety concern. If necessary, return the Product to Fluke for evaluation.
- The battery door must be closed and locked before you operate the Product.
- Replace the batteries when the low battery indicator shows to prevent incorrect measurements.
- Repair the Product before use if the battery leaks.
- Be sure that the battery polarity is correct to prevent battery leakage.

- Batteries must only be changed in an area known to be non-hazardous. Explosion hazard.
- Remove the batteries if the Product is not used for an extended period of time, or if stored in temperatures above 50 °C. If the batteries are not removed, battery leakage can damage the Product.
- Have an approved technician repair the Product.









**⚠ Caution**

To avoid possible damage to Product or to equipment under test:

- If the display reads “OL” the range limit is exceeded and the pressure source must immediately be reduced.
- Always apply thread seal tape to the threads of the gauge.
- Do not exceed the maximum torque allowed. Maximum torque allowed is 13.5 Nm = 10 lbft.

Table 1 lists the symbols that can be used on the Product or in this manual.

**Table 1. Symbols**

Symbol	Description
	WARNING - RISK OF DANGER. Consult user documentation.
	Battery status
	Battery
	Conforms to European Union directives.
	Certified by CSA Group to North American safety standards.
	Conforms to relevant Australian Safety and EMC standards.
	Conforms to relevant South Korean EMC Standards.
	Conforms to the European Explosive Atmospheres (ATEX) directive.
	This product complies with the WEEE Directive marking requirements. The affixed label indicates that you must not discard this electrical/electronic product in domestic household waste. Product Category: With reference to the equipment types in the WEEE Directive Annex I, this product is classed as category 9 "Monitoring and Control Instrumentation" product. Do not dispose of this product as unsorted municipal waste.

## Ex-Hazardous Areas

An Ex-hazardous area as used in this manual refers to an area made hazardous by the potential presence of flammable or explosive vapors. These areas are also referred to as hazardous locations, see NFPA 70 Article 500.

## Display and Buttons

Table 2 lists the features of the Product.

Table 2. Product Features

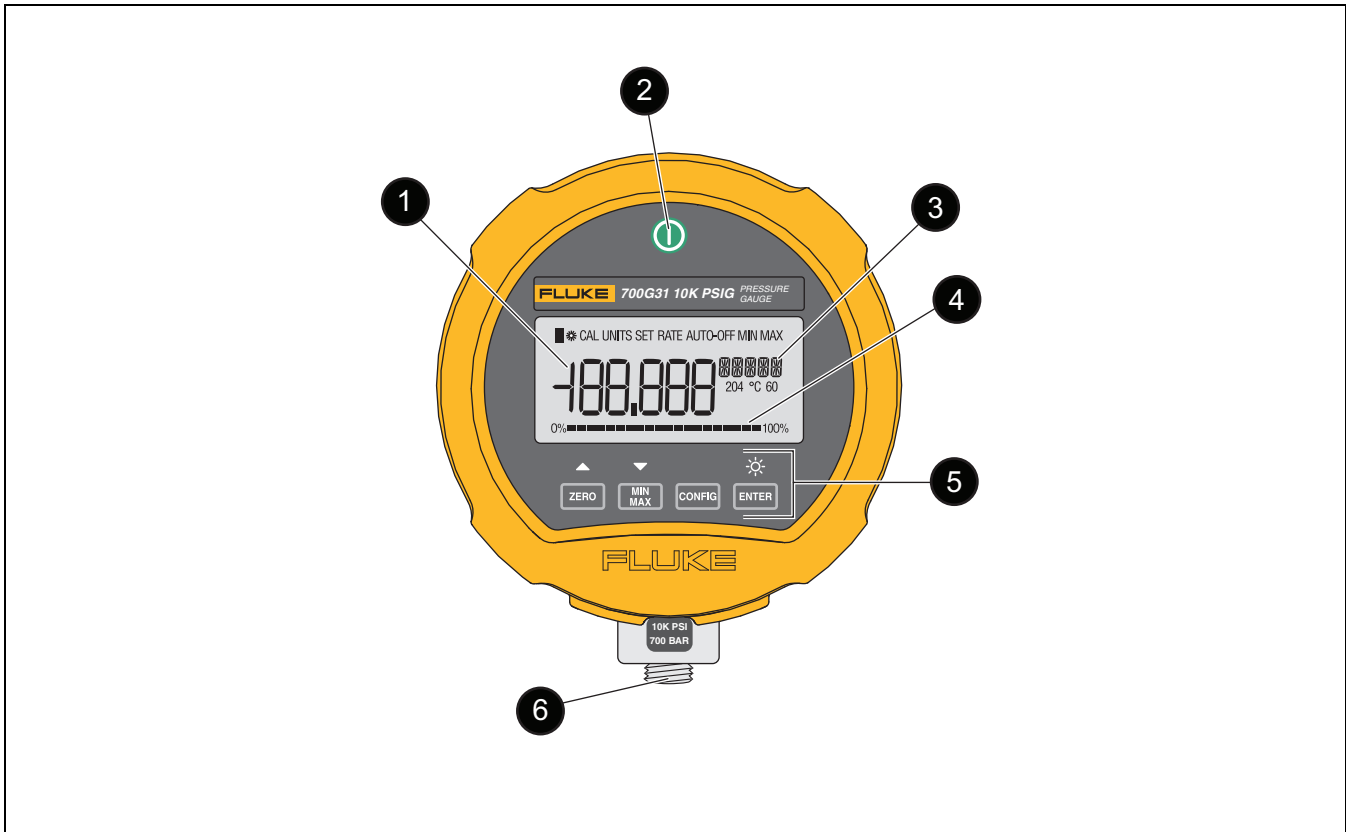





Item	Description	Item	Description
1	Pressure value	4	Bar graph
2	On/Off button	5	Control panel
3	Pressure unit	6	1/4 in NPT Connector



## Control Panel

The control panel is used to change settings or select functions and options. Table 3 lists the functions of the buttons on the Control Panel.

**Table 3. Control Panel**

Item	Default Function	Setup Mode Function
	Zeros the display. <i>Note</i> <i>For absolute versions of the gauge, push to set the barometric reference pressure.</i>	Within a function, push to move forward through options.
	The Product records minimum and maximum pressure values and saves them in memory. Push 1X to show the maximum (MAX) value on the display. Push 2X to show the minimum (MIN) value on the display. <i>Note</i> <i>After 2 seconds, the display shows the live operation value again.</i> To clear the MIN/MAX memory values, push and hold for 2 seconds until <b>CLr</b> shows on the display.	Within a function, push to move backward through options.
	Opens the Setup menu to configure the Product.	Push to cycle through the functions. Within a function, push to set the option and go back to the Setup menu.
	Toggles the backlight on/off.	Within a function, push to set the option and go back to the live view.

## Basic Operation

Push  to turn on/off the Product. To maximize the life of the batteries, use the Auto Off feature. See Table 4.

The analog bar graph at the bottom of the display shows the applied-pressure level relative to the full range of the gauge.

### *Note*

*If you record a Tare value, the pressure value that shows on the display is not the actual pressure applied to the gauge.*

## Setup the Product

Use the Setup menu to view and change settings.

To change settings:

1. Push **CONFIG** to open the Setup menu.
2. Push **CONFIG** again to select a function.
3. Push **▲/▼** to select an option.
4. Push **CONFIG** to set the option and go back to the previous function, or push **ENTER** to set the option and go back to live view.

Table 4 lists the functions that can be accessed, changed, locked, or unlocked in the Setup menu.

**Table 4. Functions**

Function	Option	Description
<b>UNITS</b>	<options>	Selects a pressure unit from a list of predefined common units and a custom unit/scale ( <b>CUST</b> ). See <i>Set Custom Unit/Scale</i> . See <i>Specifications</i> for a list of available units.
<b>AUTO-OFF</b>	<options>	Sets the time before the Product automatically turns off.
<b>Battery Charge</b>	--	Shows the battery voltage and a percent-of-life bar graph of the battery charge.
<b>Temperature</b>	<b>F</b>	Sets the temperature units to Celsius or Fahrenheit. The Product is temperature compensated and shows the temperature on the display that is measured by an internal sensor.
	<b>C</b>	
<b>DAMP</b>	<b>On</b>	Turns on/off the damper. The damper prevents sudden changes in pressure values when the source pressure pulsates.
	<b>Off</b>	
<b>RATE</b>	<options>	Sets the rate, in samples per second, at which the Product takes a pressure measurement and updates the value on the display.
<b>TARE</b>	<options>	Sets a constant offset value to subtract from a pressure measurement. See <i>Set Tare</i> .
<b>FUnC LOCK</b>	<options>	Shows if functions are locked. In Supervisory mode, use to lock/unlock functions to enable/disable changes to the functions. See <i>Supervisory Mode</i> .

## Set Tare

Use to set a constant offset value to subtract from a pressure measurement.

### Note

*If you record a Tare value, the pressure value that shows on the display is not the actual pressure applied to the gauge.*

For example, if a tare is set at 30 psi and the measured pressure is 37 psi, 7 psi shows on the display. If a tare is set at 30 psi and the measured pressure is 27 psi, -3 psi shows on the display.

The tare value is based on the pressure units and resolution selected. The tare value can be set to the maximum range of the gauge.

For safety, the bar graph always shows the actual pressure based on the full range of the gauge regardless of the tare position. Even when the pressure value shows "0", the bar graph shows the actual applied pressure.

## Supervisory Mode

If needed, use Supervisory mode to lock/unlock functions to enable/disable changes to the functions. If **FUnC LOCK** shows on the display, at least one function is locked. The password for Supervisory mode is "101". The password is set at the factory and cannot be changed.

To open Supervisory mode:

1. Push ▼ **ENTER**.

**0 PWRD** shows on the display.

2. Push ▲ to put in the password.

To move through the numbers in increments of 10, push and hold ▲/▼. To move through the numbers in increments of 1, push ▲/▼.

3. Push **ENTER**.

To lock/unlock a function:

1. Open Supervisory mode.
2. Push ▲/▼ to select **UnLOC** or **LOC**.
3. Push **CONFIG** to set the option.

## Set Custom Unit/Scale

Use to set a factor to multiply a pressure measurement by to make a custom unit/scale.

Example: 40 psi is the equivalent of 1000 lbs of product in a tank. To show the product weight with a 100 psi gauge, set the factor to 25. 40 psi pressure shows as 1000 (40 x 25) on the display. The units show as **CUST**.

To set a factor:

1. Go to Supervisory mode.
2. Push **CONFIG** until **SET FACTR** shows on the display.
3. Push **▲/▼** to select a factor.
4. Push **CONFIG** to set the option and go back to the previous function, or push **ENTER** to set the option and go back to live view.

## **Maintenance**

### **Clean the Product**

Clean the Product with a soft cloth dampened with water or water and weak soap.

#### **⚠ Caution**

To prevent possible damage to the Product, do not use solvents or abrasive cleansers.

#### **⚠ Caution**

For safe operation and maintenance of the product:

- Repair the Product before use if the battery leaks.
- Be sure that the battery polarity is correct to prevent battery leakage.
- Remove the batteries if the Product is not used for an extended period of time, or if stored in temperatures above 50 °C. If the batteries are not removed, battery leakage can damage the Product.
- Replace the batteries when the low battery indicator shows to prevent incorrect measurements.
- Have an approved technician repair the Product.

### **Batteries**

When the battery voltage is low,  shows on the top left of the display.

#### **⚠ Warning**

To prevent possible fire, explosion, or personal injury:

- Batteries must only be changed in an area known to be non-hazardous. Explosion hazard.
- Use replacement batteries of the same type. The replacement batteries must be the same design, chemistry, age, and manufacturer.

To replace the batteries (See Figure 1.):

1. Use a Phillips screwdriver to loosen the captive screw on the battery door.
2. Remove the battery door and seal.
3. Replace the batteries. For more information, see *Specifications*.
4. Replace the battery door and seal.

*Note*

*Align the battery door and seal properly with the Product to protect the Product from moisture and dust.*

5. Tighten the captive screw.

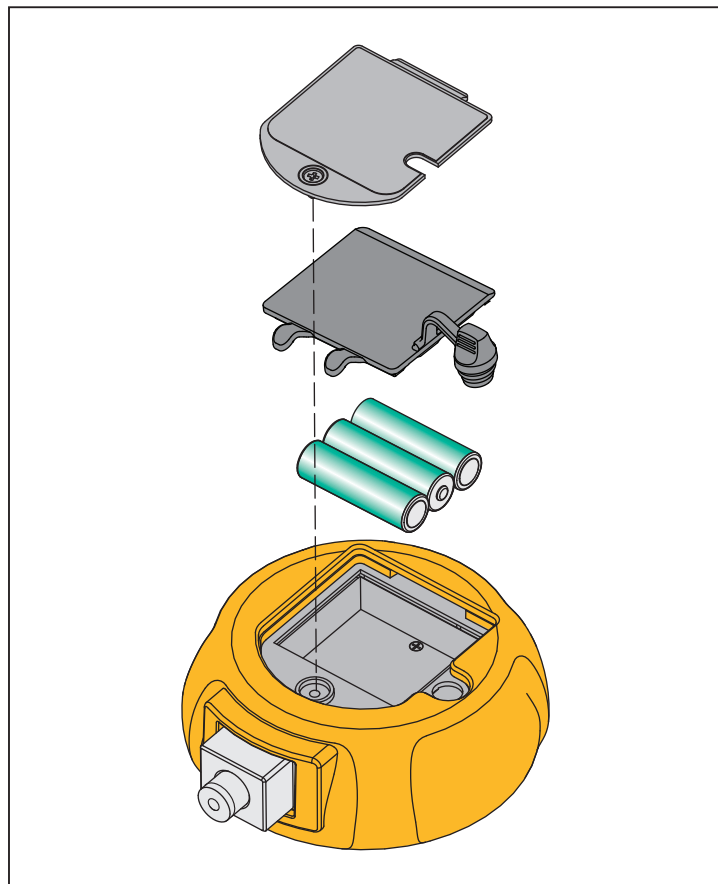

**Figure 1. Battery Replacement**

## RS-232 Interface

The Product includes an RS-232 interface. You can use serial communication to configure and calibrate the Product and move measurement data from the Product to a PC. An RS-232/USB cable is sold separately and includes 700G/TRACK Software. For specifications on the interface, see *Specifications*.

### Warning

**To prevent possible fire, explosion, or personal injury, do not use the RS-232 interface in hazardous areas. The RS-232 interface port must be sealed when used in a hazardous area.**

## Specifications

**Available Input Ranges** ..... See Ranges and Resolution tables for available ranges in psi plus equivalent ranges and resolution for all pressure units.

### Accuracy 700G Ranges

Positive Pressure (700G01, 700G02)..... $\pm 0.1$  % Full Scale  
Positive Pressure (all other ranges)..... $\pm 0.05$  % Full Scale  
Vacuum..... $\pm 0.1$  % Full Scale  
Temperature Compensation ..... 15 °C to 35 °C (59 °F to 95 °F) to rated accuracy

#### Note

*For temperatures from -10 °C to +15 °C and +35 °C to +55 °C, add 0.003 % FS / °C.*

### Accuracy 700RG Ranges

Positive Pressure..... $\pm 0.04$  % rdg  $\pm 0.01$  % Full Scale  
Vacuum (700RG05)..... $\pm 0.05$  % Full Scale  
Vacuum (all other ranges) ..... $\pm 0.1$  % Full Scale  
Temperature Compensation ..... 0 °C to +50 °C (+32 °F to +122 °F) to rated accuracy

#### Note

*For temperatures from -10 °C to 0 °C and +50 °C to +55 °C, add 0.005 % FS / °C.*

### Media Compatibility

700G01, 700G02, 700G04,  
700G05, 700RG05.....any clean, dry, non-flammable, non-corrosive gas  
All other ranges  
100 psi to 1000 psi .....any non-flammable liquids or gases compatible with 316 stainless steel  
Above 1000 psi .....any non-flammable, non-toxic, non-oxidizing liquid or gas compatible with 316 stainless steel

### Mechanical Specifications

Dimensions ..... 11.4 cm x 12.7 cm x 3.7 cm (4.5 in x 5.0 in x 1.5 in)  
Pressure  
Connection ..... 1/4 in NPT Male  
Housing ..... Cast ZNAl

**Display** ..... 5-1/2 Digits, 16.5 mm (0.65 in) high  
20-Segment bar graph, 0 % to 100 %

### Power

Battery ..... 3 x AA alkaline IEC LR6  
Battery Life..... 1500 hours without backlight (continuous on), 2000 hours at slow sample rate

**Environmental**

Temperature

Operating .....-10 °C to +55 °C (+14 °F to +131 °F)

Storage

With Batteries .....Per battery manufacturer’s specification, not to exceed storage specification without batteries.

Without Batteries .....-40 °C to +70 °C (-40 °F to +158 °F)

Altitude

Operating .....2000 m

Storage .....12 000 m

Relative Humidity.....10 % to 95 % non-condensing

Safety .....IEC 60079-0, IEC 60079-11, IEC 61010-1: Pollution Degree 2

Ingress Protection Rating .....IEC 60529: IP67 (with battery door seal and serial-port plug installed)

**Electromagnetic Compatibility (EMC)**

International.....IEC 61326-1: Portable Electromagnetic Environment; IEC 61326-2-2  
CISPR 11: Group 1, Class A

*Group 1: Equipment has intentionally generated and/or uses conductively-coupled radio frequency energy that is necessary for the internal function of the equipment itself.*

*Class A: Equipment is suitable for use in all establishments other than domestic and those directly connected to a low-voltage power supply network that supplies buildings used for domestic purposes. There may be potential difficulties in ensuring electromagnetic compatibility in other environments due to conducted and radiated disturbances.*

*Caution: This equipment is not intended for use in residential environments and may not provide adequate protection to radio reception in such environments.*

Korea (KCC) .....Class A Equipment (Industrial Broadcasting & Communication Equipment)

*Class A: Equipment meets requirements for industrial electromagnetic wave equipment and the seller or user should take notice of it. This equipment is intended for use in business environments and not to be used in homes.*

USA (FCC) .....47 CFR 15 subpart B. This product is considered an exempt device per clause 15.103.

**RS-232 Interface** .....The Serial Interface (J4) is a 3.5 mm Stereo Jack connector. Use the RS-232/USB cable sold with the 700G/TRACK Software. USB to RS-232 converter with 5 V RS-232 signals. Connection to RS-232 Interface in non-hazardous area only:  
Ui = 18 V, Pi = 0.5 W.

**Compliance Marks**



.....Class I, Division 2, Groups A-D



..... II 3 G Ex ic IIB T6 Gc

SIRA 17ATEX4160X

Input Entity Parameters:

Ta = -10 °C...+55 °C

Ui = 18 V, Pi = 0.5 W (NON HAZARDOUS AREA)

**Ranges and Resolution (700G)**

Model Number		700G01	700G02	700G04	700G05	700G06	700G27	700G07	700G08	700G10	700G29	700G30	700G31
Pressure Range (psi)		0.4	1	15	30	100	300	500	1000	2000	3000	5000	10000
Vacuum Range (psi)		-0.4	-1	-14	-14	-12	-12	-12	-14	-14	-14	-14	-14
Burst Pressure (psi)		3	5	60	120	400	1200	2000	4000	8000	10000	15000	20000
Proof Pressure (psi)		1	3	30	60	200	600	1000	2000	4000	6000	10000	15000
Engineering Unit	Factor												
psi	1.0000	0.4000	1.0000	15.000	30.000	100.00	300.00	500.00	1000.0	2000.0	3000.0	5000.0	10000
bar	0.06894757	0.0276	0.0689	1.0342	2.0684	6.8948	20.684	34.474	68.948	137.90	206.84	344.74	689.48
mbar	68.94757	27.579	68.948	1034.2	2068.4	6894.8	20684	34474	68948	*	*	*	*
kPa	6.894757	2.7579	6.8948	103.42	206.84	689.48	2068.4	3447.4	6894.8	13790	20684	34474	68948
MPa	0.006894757	0.0028	0.0069	0.1034	0.2068	0.6895	2.0684	3.4474	6.8948	13.790	20.684	34.474	68.948
kg/cm2	0.07030697	0.0281	0.0703	1.0546	2.1092	7.0307	21.092	35.153	70.307	140.61	210.92	351.53	703.07
mmHg @ 0 °C	51.71507	20.686	51.715	775.73	1551.5	5171.5	15515	25858	51715	*	*	*	*
inHg @ 0 °C	2.03603	0.8144	2.0360	30.540	61.081	203.60	610.81	1018.0	2036.0	4072.1	6108.1	10180	20360
cmH2O @ 4 °C	70.3089	28.124	70.309	1054.6	2109.3	7030.9	21093	35154	70309	*	*	*	*
cmH2O @ 20 °C	70.4336	28.173	70.434	1056.5	2113.0	7043.4	21130	35217	70434	*	*	*	*
mmH2O @ 4 °C	703.089	281.24	703.09	10546	21093	70309	*	*	*	*	*	*	*
mmH2O @ 20 °C	704.336	281.73	704.34	10565	21130	70434	*	*	*	*	*	*	*
mH2O @ 4 °C	0.703089	0.2812	0.7031	10.546	21.093	70.309	210.93	351.54	703.09	1406.2	2109.3	3515.4	7030.9
mH2O @ 20 °C	0.704336	0.2817	0.7043	10.565	21.130	70.434	211.30	352.17	704.34	1408.7	2113.0	3521.7	7043.4
inH2O @ 4 °C	27.68067	11.072	27.681	415.21	830.42	2768.1	8304.2	13840	27681	55361	83042	*	*
inH2O @ 20 °C	27.72977	11.092	27.730	415.95	831.89	2773.0	8318.9	13865	27730	55460	83189	*	*
inH2O @ 60 °F	27.70759	11.083	27.708	415.61	831.23	2770.8	8312.3	13854	27708	55415	83123	*	*
ftH2O @ 4 °C	2.306726	0.9227	2.3067	34.601	69.202	230.67	692.02	1153.4	2306.7	4613.5	6920.2	11534	23067
ftH2O @ 20 °C	2.310814	0.9243	2.3108	34.662	69.324	231.08	693.24	1155.4	2310.8	4621.6	6932.4	11554	23108
ftH2O @ 60 °F	2.308966	0.9236	2.3090	34.634	69.269	230.90	692.69	1154.5	2309.0	4617.9	6926.9	11545	23090
ft Sea Water	2.24719101	0.8989	2.2472	33.708	67.416	224.72	674.16	1123.6	2247.2	4494.4	6741.6	11236	22472
m Sea Water	0.68494382	0.2740	0.6849	10.274	20.548	68.494	205.48	342.47	684.94	1369.9	2054.8	3424.7	6849.4
Torr	51.71507	20.686	51.715	775.73	1551.5	5171.5	15515	25858	51715	*	*	*	*

\* - range will not be displayed due to limitations on display resolution. In all cases, resolution is limited to 100,000 counts.



**Ranges and Resolution (700GA and 700RG)**

Model Number		700GA4	700GA5	700GA6	700GA27	700RG05	700RG06	700RG07	700RG08	700RG29	700RG30	700RG31
Pressure Range (psi)		15 PSIA	30 PSIA	100 PSIA	300 PSIA	30	100	500	1000	3000	5000	10000
Vacuum Range (psi)		0 PSIA	0 PSIA	0 PSIA	0 PSIA	-14	-12	-12	-14	-14	-14	-14
Burst Pressure (psi)		60	120	400	1200	90	400	2000	4000	10000	15000	20000
Proof Pressure (psi)		30	60	200	600	60	200	1000	2000	6000	10000	15000
Engineering Unit	Factor											
psi	1.0000	15.000	30.000	100.00	300.00	30.000	100.000	500.00	1000.00	3000.0	5000.0	10000.0
bar	0.06894757	1.0342	2.0684	6.8948	20.684	2.0684	6.8948	34.474	68.948	206.84	344.74	689.48
mbar	68.94757	1034.2	2068.4	6894.8	20684	2068.4	6894.8	34474	68948	*	*	*
kPa	6.894757	103.42	206.84	689.48	2068.4	206.84	689.48	3447.4	6894.8	20684	34474	68948
MPa	0.006894757	0.1034	0.2068	0.6895	2.0684	0.2068	0.6895	3.4474	6.8948	20.684	34.474	68.948
kg/cm2	0.07030697	1.0546	2.1092	7.0307	21.092	2.1092	7.0307	35.153	70.307	210.92	351.53	703.07
mmHg @ 0 °C	51.71507	775.73	1551.5	5171.5	15515	1551.5	5171.5	25858	51715	*	*	*
inHg @ 0 °C	2.03603	30.540	61.081	203.60	610.81	61.081	203.60	1018.0	2036.0	6108.1	10180	20360
cmH2O @ 4 °C	70.3089	1054.6	2109.3	7030.9	21093	2109.3	7030.9	35154	70309	*	*	*
cmH2O @ 20 °C	70.4336	1056.5	2113.0	7043.4	21130	2113.0	7043.4	35217	70434	*	*	*
mmH2O @ 4 °C	703.089	10546	21093	70309	*	21093	70309	*	*	*	*	*
mmH2O @ 20 °C	704.336	10565	21130	70434	*	21130	70434	*	*	*	*	*
mH2O @ 4 °C	0.703089	10.546	21.093	70.309	210.93	21.093	70.309	351.54	703.09	2109.3	3515.4	7030.9
mH2O @ 20 °C	0.704336	10.565	21.130	70.434	211.30	21.130	70.434	352.17	704.34	2113.0	3521.7	7043.4
inH2O @ 4 °C	27.68067	415.21	830.42	2768.1	8304.2	830.42	2768.1	13840	27681	83042	*	*
inH2O @ 20 °C	27.72977	415.95	831.89	2773.0	8318.9	831.89	2773.0	13865	27730	83189	*	*
inH2O @ 60 °F	27.70759	415.61	831.23	2770.8	8312.3	831.23	2770.8	13854	27708	83123	*	*
ftH2O @ 4 °C	2.306726	34.601	69.202	230.67	692.02	69.202	230.67	1153.4	2306.7	6920.2	11534	23067
ftH2O @ 20 °C	2.310814	34.662	69.324	231.08	693.24	69.324	231.08	1155.4	2310.8	6932.4	11554	23108
ftH2O @ 60 °F	2.308966	34.634	69.269	230.90	692.69	69.269	230.90	1154.5	2309.0	6926.9	11545	23090
ft Sea Water	2.24719101	33.708	67.416	224.72	674.16	67.416	224.72	1123.6	2247.2	6741.6	11236	22472
m Sea Water	0.68494382	10.274	20.548	68.494	205.48	20.548	68.494	342.47	684.94	2054.8	3424.7	6849.4
Torr	51.71507	775.73	1551.5	5171.5	15515	1551.5	5171.5	25858	51715	*	*	*

\* - range will not be displayed due to limitations on display resolution. In all cases, resolution is limited to 100,000 counts.

