

# 800G/400G Power Blazer

MULTISERVICE TEST MODULE FROM 1G TO 800G

- Most flexible and future-proof 1G to 800G multiservice test solution for lab and field applications, supporting current 400G/200G transceivers and next-gen pluggables.



## KEY FEATURES AND BENEFITS

400G/200G/100G Ethernet testing capabilities based on the IEEE 802.3bs and IEEE 802.3ba standard

Complete Ethernet test suite at 1G, 10G, 25G, 40G, 50G, 100G, 200G and 400G with EtherBERT, RFC 2544, EtherSAM Y.1564, smart loopback and traffic generation and monitoring

State-of-the-art Open Transceiver System (OTS) design for full flexibility with current and future transceivers

Flex Ethernet (FlexE) 2.0 testing capabilities with low and high speed Ethernet clients supported on 4 x QSFP28 ports and QSFP-DD port

Flexible solution that uniquely supports current CFP8, QSFP-DD, OSFP and CFP2-DCO interfaces as well as next-gen interfaces (e.g., digital coherent optics like 400G ZR, Open ZR+, Open ROADM)

Compatible with EXFO's LTB-8 Rackmount Platform featuring hot-swap capability for lab use and best-in-class 400G port density with up to two modules running simultaneously

Compatible with the portable FTB-4 Pro Platform for the most compact 400G solution—ready for the lab-to-field transition

OTUCn/FlexO BER testing capabilities supporting 100G, 200G, 300G and 400G mapped in ODUflex over 400G interfaces

Supports quick optical transceiver validation and sanity check using iOptics, an intelligent pluggable optics test application

Pre-emphasis and Rx equalization tools to modify the waveform for better eye opening at the destination

PAM4 histogram: provides a graphic view from PAM4 eye diagram per lane, including PAM4 levels

Compatible with 2 x 100GE, 4 x 100GE, 2 x 200GE and 8 x 50GE breakout cables providing validation tools per link

OTN BERT testing capabilities for OTU1 to OTU4 (112 Gbit/s), Ethernet mapping over OTN, single and multistage ODU multiplexing as well as OTN service disruption time (SDT) measurements

## RELATED PRODUCTS AND ACCESSORIES



Platform  
FTB-4 Pro



Rackmount platform  
LTB-8



Multi-user interface  
EXFO Multilink

## 400G TO THE RESCUE

Network infrastructure planners must deal with skyrocketing demands for more bandwidth, including in the data center interconnect (DCI) or even in core and metro networks. Network equipment manufacturers (NEMs) continue to push the limits of technology, developing increasingly innovative 400G solutions. Service providers are constantly expanding their networks, looking for more efficient and cost-effective ways to deploy those high-speed circuits. High-speed transceivers (pluggables) are being designed to be smaller and consume less power in order to meet the requirements of delivering high port density at a low cost. In the upcoming 400G world, transceiver testing is of critical importance whenever we are talking about QSFP-DD, OSFP, or even COBO.

The industry is moving forward with smaller, advanced transceivers for shorter wavelengths and with lower power consumption. EXFO offers 400G solutions that are ready for today's 400G transceivers while being future-proof. 400G switches are migrating quickly to advanced technologies with interfaces that will allow them to increase the port density in a 1RU at minimal cost.

## COMPATIBLE WITH PORTABLE AND RACKMOUNT PLATFORMS

The FTBx-88460 Power Blazer module offers a complete suite of 400G ecosystem testing capabilities, addressing early adopters' requirements from in-lab innovation to testing in the field. In addition, when portability is needed the FTBx-88460 module can be inserted into the FTB-4 Pro. The module can also serve for rackmount applications, where not only one but two modules can be inserted into the high-performance LTB-8 rackmount chassis to deliver up to 800G of Ethernet traffic. The LTB-8 rackmount platform provides users with added versatility and power for today's complex networks.

## 400G TESTING MODULE—FTBX-88460 POWER BLAZER

The FTBx-88460 offers powerful and advanced 400G ecosystem testing. The addition of the OTS makes it uniquely suited to adjust to the specific transceiver required for the test.



## DESIGNED FOR FLEXIBILITY

The OTS design provides enhanced flexibility and CAPEX protection to the end user; one test module can support various types of transceivers. A flexible solution that can adapt and adjust to the fast evolution of transceivers while providing multirate support.

The FTBx-88460 can also be configured with only a filler for FlexE and FlexO testing applications.

- ❶ 400G/200G/100G transceiver supporting Ethernet, OTN, FlexE, OTUCn/FlexO and coherent optics
- ❷ 4 x QSFP28 ports supporting FlexE and OTUCn/FlexO up to 400G, Ethernet testing at 1, 10, 25, 40, 50 and 100GE
- ❸ REF CLOCK OUT SMA interface
- ❹ Synchronization SMB interface (input 1PPS, 10 MHz or 2 MHz)



## INTERFACES

QSFP28	4 lanes and 1 lane
CFP8	8 lanes
QSFP-DD	8 lanes, 4 lanes, 400G ZR and OpenZR+
QSFP56	4 lanes
OSFP	8 lanes, 4 lanes, 400G ZR and OpenZR+
CFP2-DCO	400ZR, OpenZR+ and OpenROADM

## DUAL PORT CAPABILITIES

### Multiple configurations available

- Dual port**
- 2 x QSFP-DD
  - 2 x OSFP
  - 2 x CFP2-DCO

- Mix port**
- 1 x QSFP-DD and 1 x OSFP
  - 1 x QSFP-DD and 1 x CFP2-DCO
  - And more



Only tester on the market capable of validating 2 x CFP2-DCO

## RAPID EVOLUTION OF TRANSCEIVERS

A shared challenge in the telecom industry today is the wide variety of pluggable transceivers available and the rapid rate at which new types of transceivers are being launched. This growing challenge impacts equipment manufacturers trying to keep up as well as network operators/data centers trying to integrate new transceivers into their networks.

With that in mind, the latest addition to the Power Blazer family of test modules—the FTBx-88460—comes with a new design concept using OTS which allows users to customize the type of interfaces on the module according to their needs, without using adapters, while also ensuring the future-proof capacity to test new transceivers as they become available, by simply changing the transceiver system instead of having to purchase a new test unit.



## HIGH SPEED ETHERNET TESTING

400G Ethernet is the promising replacement for 100G Ethernet. 400G is becoming the next client rate in the Ethernet ecosystem as the industry ramps up to handle the massive demands of hyperscale data centers, 5G applications, service providers and business users. The FTBx-88460 offers advanced Ethernet testing capabilities, including forward error correction monitoring and validation.

### 400G/200G/100G/50G/40G/25G/10G/1G\* framed/unframed Ethernet testing capabilities

- 400G/200G/100G Ethernet MAC PCS/PMA/PMD layer testing
- 400G/200G FEC RS (544, 514) decoding and error correction
- Test pattern monitoring
- MDIO/I2C for all interfaces read/write
- Alarms/errors generation and monitoring
- Per lanes PRBS unframed testing with pass/fail verdict
- CMIS support with loopback testing

\* 1G, 10G and 25G use a QSFP28 to SFP28 adapter

### Advanced testing capabilities

- Skew measurement per lane
- FEC testing
- BER monitoring
- Advanced error analysis
- SDT measurement
- Ethernet traffic filtering
- Unframed BER testing (including PRBS31Q, PRBS13Q and SSPRQ patterns)
- Pre-emphasis and Rx equalizer for the capability to modify the signal for better eye opening
- PAM4 histogram
- Host and media side configuration



### Unframed BERT

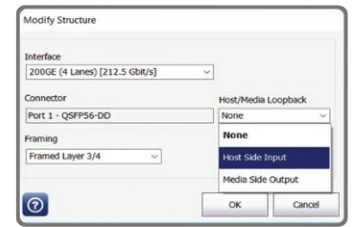
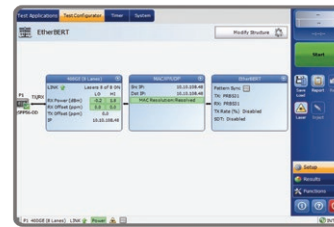

iOptics is an intelligent pluggable optics test application and first-alert test that can be used in the field or lab to efficiently evaluate the proper operation of an optical interface, with minimal user configuration required. iOptics performs validation using several subtests, monitors power consumption and temperature and reports an individual verdict for each subtest and monitoring task. iOptics now supports the latest high-speed pluggables from 1G to 400G transceivers, AOC and DAC cables. iOptics now offers loopback settings for internal transceiver fault isolation.

SFP/SFP+/SFP28



QSFP+/QSFP28



QSFP-DD



AOC cables



DAC cables





## BREAKOUT CABLES

The constant traffic growth generated by IoT, 5G and online gaming is pushing network operators and data center administrators to migrate to higher rates like 200GE and 400GE. In addition to the challenge of adapting to the complexity of new technologies, administrators have to find flexible and cost-effective solutions to reuse their current 100GE infrastructure. This is where the capability to break or fan-out 400GE/200GE ports into multiple 200GE/100GE/50GE links becomes key as it allows users to aggregate fibers slowly into higher bandwidth ports as they move along to higher rates.

There are several breakout variants: 2 x 100GE, 4 x 100GE, 2 x 200GE, and 8 x 50GE. The following image shows an example from a 4x100G breakout interconnection:

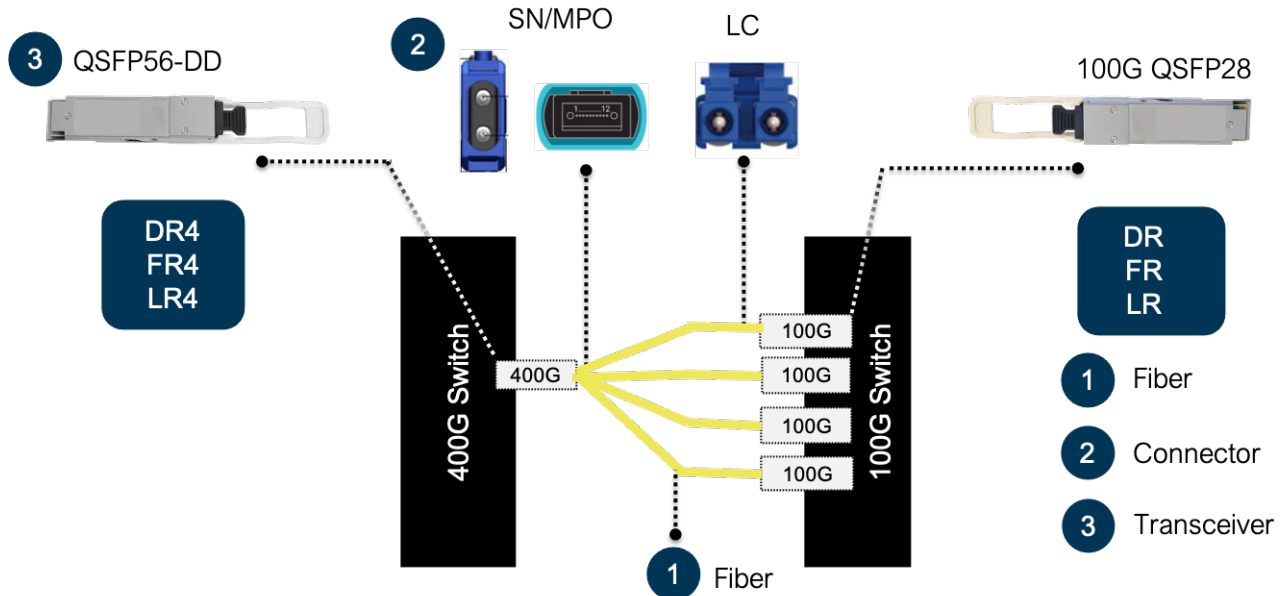

These interconnections require validation of each link independently; the transceivers on each side as well as the connectors and fibers involved. EXFO's FTBx-88460 verifies each one of these elements including L2/L3 capabilities, statistics per link, power levels and error injection, allowing technicians to pinpoint any potential failure quickly and easily.



## IMPROVING THE TRANSMISSION SIGNAL

The adoption of PAM-4 (which stands for pulse amplitude modulation) as the new modulation for current and future interfaces on the high speed market brings new challenges, PAM-4 electrical eyes are smaller in comparison to the typical modulation used for 100G non-return-to-zero (NRZ) technologies.

The characteristics of this modulation may generate a less efficient OSNR. Lab technicians require tools to manipulate the transmission signal and improve the eye diagram making it more visible.

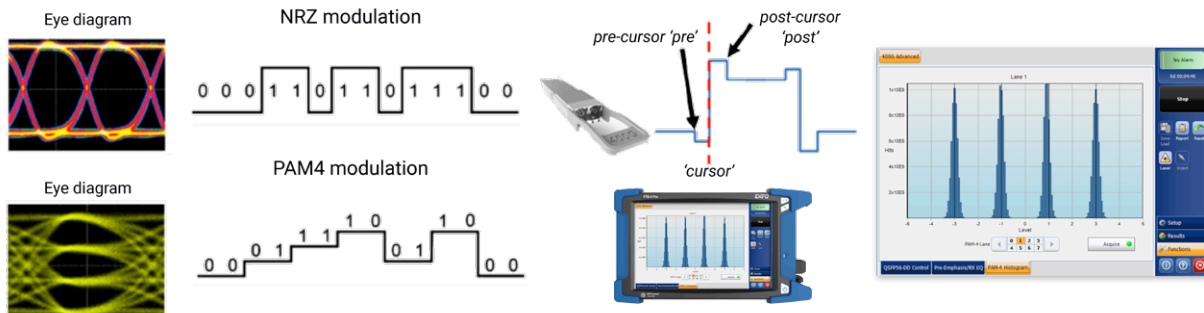

Pre-emphasis and Rx equalizer tools help users adjust and manipulate the signal characteristics for Tx (cursor and eye location) and Rx (including different types of DSP modes) validating each lane of the pluggable under test. Once these parameters are modified, users need to identify the impact these parameters have over the PAM4 eye diagram. Our PAM4 histogram tool provides a detailed graphical view of each lane diagram directly on the screen of the tester, showing values for each PAM4 level.

## RFC 2544

As 400G moves from the lab to the field (the first 400G deployments are imminent), ensuring service quality at turn-up is becoming key. Portable 1G to 400G test equipment will enable field technicians and contractors to immediately capture test results and demonstrate that the Ethernet service meets SLAs. These tests may also serve as a performance baseline for future reference.

From a laboratory and benchmarking perspective, RFC 2544 methodology is ideal for automated measurement and reporting. From a service turn-up and troubleshooting perspective, RFC 2544 provides an out-of-service benchmarking methodology for evaluation of network/device performance using four subtests with up to 10 configurable frame sizes, each validating a specific portion of an SLA. RFC 2544 provides engineers and network technicians with a common language and results format.

RFC2544 includes the following subtests:

- 1 Throughput
- 2 Back-to-back (Burstability)
- 3 Frame loss
- 4 Latency

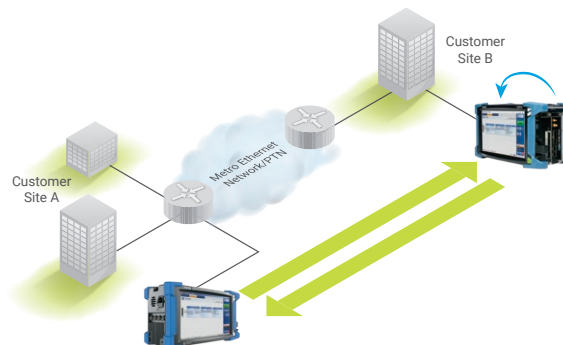

## SMART LOOPBACK

EXFO smart loopback is a unique functionality that enables loopback Ethernet traffic at all rates from a user-datagram protocol (UDP) or transmission-control-protocol (TCP) layer, or all the way down to a completely promiscuous mode (transport loopback). The modules can adjust to all loopback situations where the remote unit will return traffic to the local unit by swapping packet overhead up to layer 4 of the OSI stack.



## DIGITAL COHERENT PLUGGABLES

The OIF MSA standard has introduced a few WDM interfaces that leverage digital coherent optics (DCO). 400G OIF ZR, Open ZR+ and Open ROADM are the most popular ones, used for optimal connectivity in data center interconnect and metro applications. These transceivers offer reaches from 80 km to +120 km (see figure below with test configurations). The main form factors for these types of optics are OSFP and QSFP-DD. The most popular rates for these transceivers are 100G, 200G, 300G and 400G. EXFO's FTBx-88460, with its unique OTS, supports the form factors QSFP-DD, OSFP and CFP2-DCO for client and DCO applications.



EXFO's FTBx-88460 advanced DCO capabilities include:

- Configurable Tx power
- Configurable wavelength
- Display from pluggable optical metrics like CD, OSNR, etc.
- 400G client L2 to L4 configuration capabilities
- Media Rx FEC alarm and error monitoring
- And more

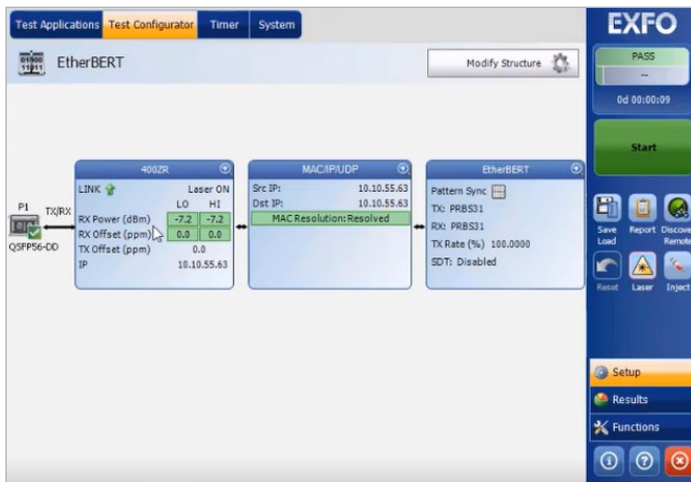

DCO Bert generation and analysis

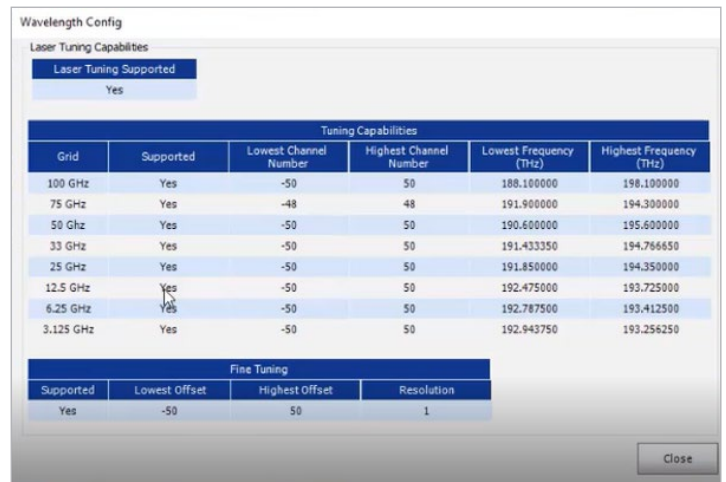

Wavelength tuning

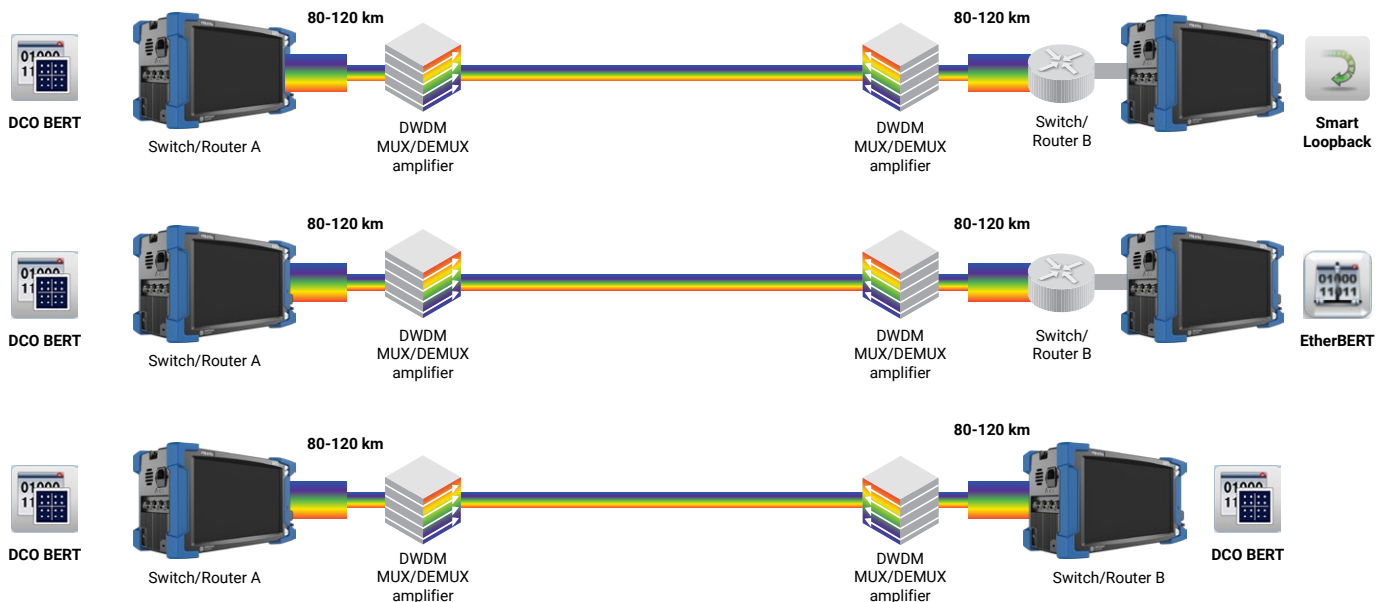

## ETHERNET TRAFFIC GENERATION AND MONITORING

Data services carried over high-speed networks are making a significant shift towards a variety of applications. Multiservice offerings, such as triple-play services have fueled the need for QoS testing to ensure the condition and reliability of each service, and qualify SLA parameters. With traffic generation and monitoring, high-speed modules allow service providers to simultaneously simulate and qualify different applications. Up to 16 streams can be configured with different Ethernet and IP QoS parameters, such as VLAN ID (802.1Q), VLAN priority (802.1p), VLAN stacking (802.1ad Q-in-Q), ToS and DSCP.

In addition, the modules support monitoring of multiple VLAN streams through the Traffic Scan functionality. In the same line, a MAC flooding capability is available for switch-addressable memory testing, where the range of MAC addresses can be cycled, forcing the switch to learn every single one. The modules offer the flexibility to define one configuration profile and apply it to as many streams as required. From there, it is just a matter of tweaking them to each stream. They also simultaneously measure throughput, latency, packet jitter (RFC 3393), frame loss and out-of-sequence errors in all streams, yielding fast and in-depth qualification of all SLA criteria. Results are displayed in tabular format and on analog visual gauges to ensure that test outcomes are quickly and easily interpreted.

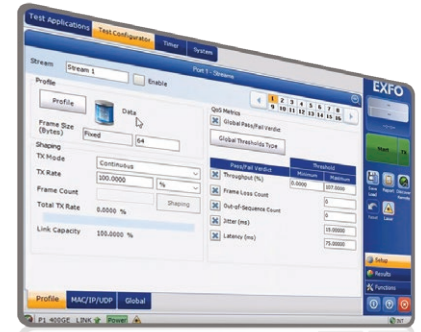

## ETHERSAM: ITU-T Y.1564 ETHERNET SERVICE ACTIVATION

With more and more Ethernet services being activated today, the ITU-T Y.1564 standard addresses the growing demand for turning up and troubleshooting Carrier Ethernet services. The Power Blazer modules support Ethernet client services, including validation of critical SLA criteria, such as packet jitter and quality-of-service (QoS) measurements, as well as faster time-to-service. EXFO's EtherSAM test suite—based on the ITU-T Y.1564 Ethernet service activation methodology—provides comprehensive field testing for mobile backhaul and commercial services. EtherSAM can simulate all types of services that will run on the network and simultaneously qualify all key SLA parameters for each of these services.

Moreover, it validates the QoS mechanisms provisioned in the network to prioritize the different service types, resulting in better troubleshooting, more accurate validation and much faster deployment. EtherSAM is comprised of two phases:

1. Service configuration test
2. Service performance test

### Service configuration test

The service configuration test consists of sequentially testing each service. It validates that the service is properly provisioned and that all specific KPIs or SLA parameters are met.

### Service performance test

Once the configuration of each individual service is validated, the service performance test simultaneously validates the quality of all the services over time. In addition, EtherSAM's approach proves even more powerful as it executes the complete ITU-T Y.1564 test bidirectionally. Key SLA parameters are measured independently in each test direction, thus providing 100% first-time-right service activation—the highest level of confidence in service testing.

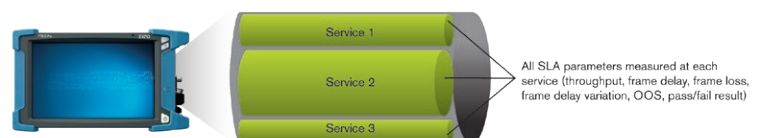
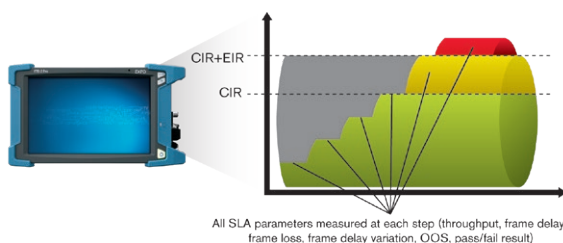
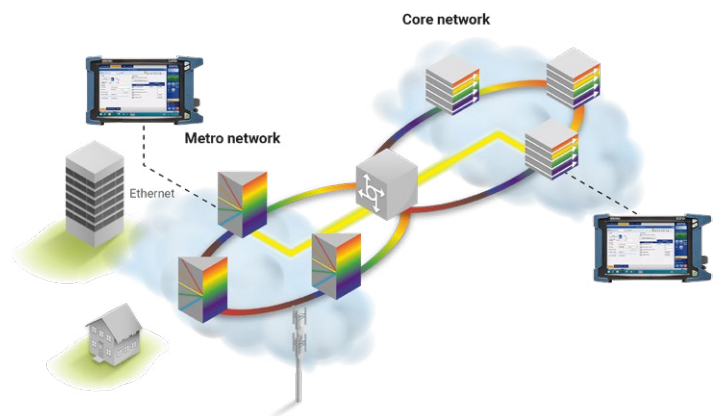



## FlexE (Flex ETHERNET)

The Flex Ethernet (FlexE) supports one or more bonded 100G/200G/400G PHYs supporting multiple and mixed Ethernet MAC clients operating at rates of 5, 10, 25, 40, 50, 100 or up to 400 Gbit/s. Flex Ethernet is a key technology for data centers, helping them deliver links that are faster than emerging 400G solutions. It will also support sub-rate links i.e., 10G, 25G and 50G, which are essential for data centers but also for carriers that need to isolate their traffic.

### FlexE testing capabilities

- FlexE group
- FlexE 2.0 support
- Mixed Ethernet client types
- Client ID edition
- FlexE shim configuration
- FlexE alarms/errors generation and monitoring
- Alignment marker corruption and substitution
- Full client to calendar slot assignment edition capabilities
- FlexE Path OAM
- FlexE OAM APS
- FlexE OH Edition

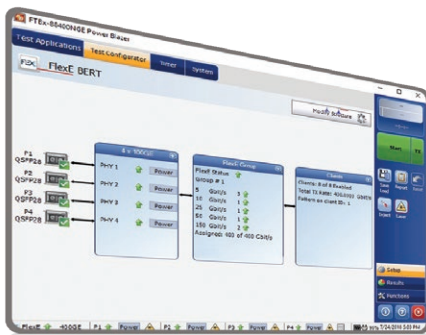

Ethernet multiclients

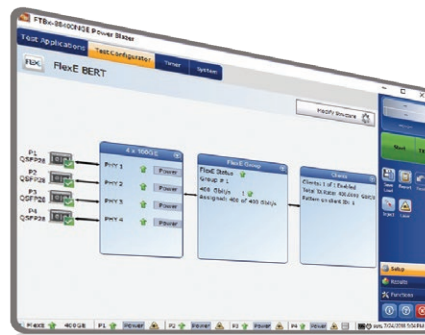

400GE single client

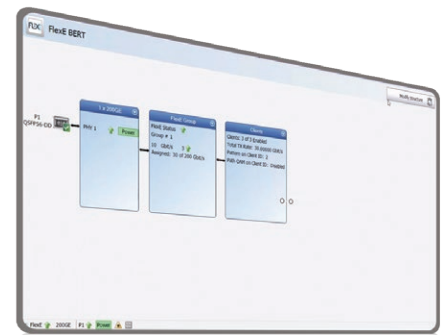

FlexE 2.0



FlexE OAM



FlexE Overhead

## OPTICAL TRANSPORT NETWORK (OTN) TESTING

OTN (ITU-T G.709) is a transport technology that provides granular detail in different areas, including operations, administration and provisioning. It even offers tools for maintenance and troubleshooting, making it the technology of choice for 40G/100G networks.

The Power Blazer Series offers numerous OTN testing capabilities, enabling breakthrough level qualification of 10G, 40G and 100G transponders and muxponders in network equipment manufacturer (NEM) labs. These capabilities include OTU1 (2.6660 Gbit/s), OTU2 (10.7092 Gbit/s), OTU1e (11.0491 Gbit/s), OTU2e (11.0957 Gbit/s), OTU1f (11.2701 Gbit/s), OTU2f (11.3176 Gbit/s), OTU3 (43 Gbit/s), overlocked OTU3 including OTU3e1 (44.57 Gbit/s), OTU3e2 (44.58 Gbit/s) and OTU4 (112 Gbit/s), Ethernet mapping over OTN, single and multistage ODU multiplexing as well as OTN service disruption time (SDT) measurements including ODU0 and ODUflex mapping to address the growing demand for Ethernet service turn-up.

### ODUflex

There are many fixed OTN rates, including OTU2 (10 Gbit/s), OTU3 (43 Gbit/s) and OTU4 (112 Gbit/s). On the other side, ODUflex provides the ability to create a container that is appropriately sized for the data rate of the client, offering a single manageable entity across the OTN that can be permanently fixed for CBR clients, or adjusted based on connectivity demand in the network using the generic framing procedure (GFP). ODUflex uses 1.25 Gbit/s tributary time slots (ODTUGk) to create the variable container in which a client signal is mapped and then transported. Using ODUflex in carrier networks brings significant benefits, including higher efficiency for network configuration and bandwidth allocation and also provides a future-proof solution for transporting any client signal at any rate, when needed.

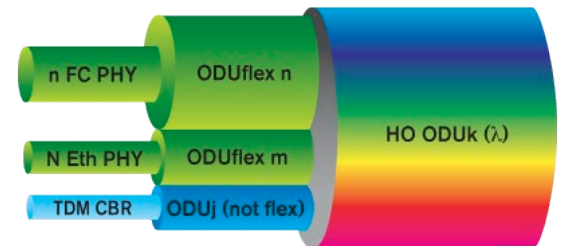

### OTUCn/FlexO

OTN is a key transport technology for several applications (e.g., metro, core) that continues to evolve and adapt to bandwidth challenges. The adoption of the OTUCn/FlexO standard (part of ITU G.709) enables OTN to become more flexible and evolve more efficiently as future Ethernet standards and transport technologies emerge.

The aim is to provide a long-term evolution of this protocol that can carry, in a flexible manner, payload based on bandwidth demands.

EXFO's OTUCn/FlexO BER solution supports testing up to 419G mapped in ODUflex over 1, 2, 3 or 4 FOIC1.4 interfaces for 100G, 200G and 400G FlexO, respectively. With powerful tools for injecting and monitoring OTUCn/FlexO alarms and errors, network equipment manufacturers, data centers and carrier labs are now equipped to validate transport elements including this new standard of the 400G ecosystem.

### OTUCn/FlexO capabilities

- OTUC4 419G CBR client mapped into ODUflex
- OTUC1, OTUC2, OTUC3 and OTUC4 CBR client mapped in ODUflex
- OTUCn alarm/error monitoring and injection
- OTUCn trace/payload type configuration and monitoring
- FlexO group mapped over FOIC1.4 interfaces
- FlexO alarm/error monitoring and injection
- Excessive skew alarms are reported for FlexO Instances and FOIC1.4 lanes in the Alarms/Errors pages
- FOIC1.4 lane alignment marker monitoring

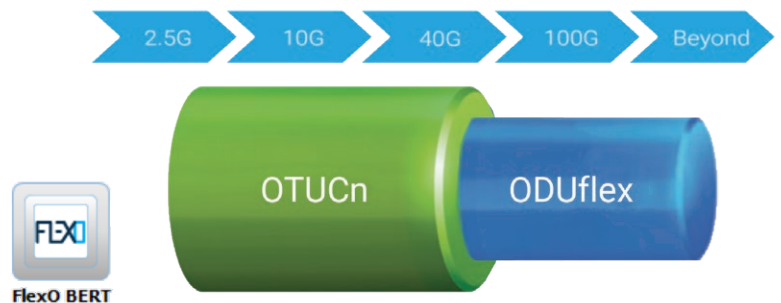

## SOFTWARE TEST TOOLS

These platform-based software testing tools enhance the value of the LTB-8 and FTB-4 Pro platforms, providing additional monitoring and inspection testing capabilities.

# ConnectorMax

## Software applications

Providing lightning-fast results in the first step of fiber link testing, ConnectorMax2 is a powerful platform-based, automated inspection application. It delivers quick pass/fail assessment of connector endfaces and is designed to save time and money, in the field and in the lab.

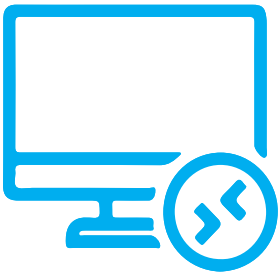

### Remote control

The Windows-based design enables remote operation through TeamViewer, Remote Desktop (RDP), Virtual Network Computing (VNC), Microsoft Teams and the free remote software, EXFO Remote Toolbox:

- Perform tests and evaluations remotely
- Enjoy easy remote access by connecting to a fixed/wireless Ethernet network or hotspot—no need to connect to the customer network
- Perform automation tasks using SCPI and Python in an automated test environment



## EXFO | MULTILINK

The value of connectivity comes from the ability to connect your platform anywhere, at any time. The EXFO Multilink **multi-module**, **multi-user** and **multi-chassis** application enables the remote control access of each chassis and module through a centralized network.

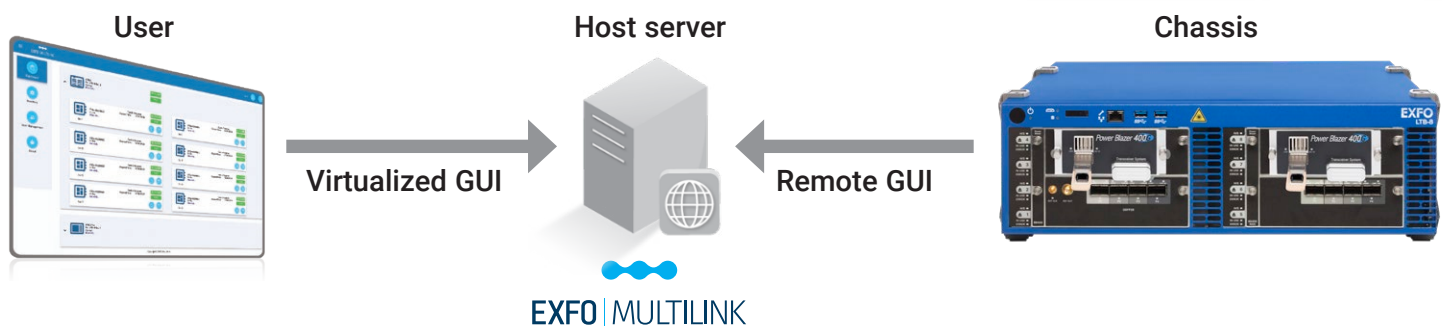

## EXFO | Connect

### EXFO Connect makes your data mean business

EXFO Connect completely redefines integrated testing with its cloud-hosted solution. Equipped with powerful database and application technologies, EXFO Connect provides an automated, secure environment that links together your EXFO test instruments and centralizes your test reports.

**MECHANICAL AND ENVIRONMENTAL SPECIFICATIONS**

Size (H x W x D)	101 mm x 159 mm x 175 mm (4 in x 6 1/4 in x 6 7/8 in)	
Weight	1.70 kg 3.75 lb <sup>a</sup>	
Temperature	Operating	0 °C to 40 °C (32 °F to 104 °F)
	Storage	-40 °C to 70 °C (-40 °F to 158 °F)

**REF-OUT INTERFACE**

Tx pulse amplitude	200 mVpp to 1300 mVpp, depending on frequency	
Transmission frequency	155 MHz to 3.50 GHz	
Output configuration	AC-coupled	
Load impedance	50 Ω	
Connector type	SMA	
External cable	Maximum 1 meter cable length (RG178 cable with 3.1 dB/m attenuation at 3.5 GHz)	

**LASER SAFETY**

Module: The host unit that you use with your module may have different laser classes. Refer to the host unit documentation for exact information.

a. With filler.



SUMMARY OF KEY FEATURES	
Detailed compliance testing	IEEE 802.3ba and IEEE 802.3bs standard
Multi-interface support	Pluggable MSA-compliant 4 x 25G QSFP28 transceivers AOC QSFP28/QSFP-DD cable support CFP MSA management interface specification version 2.6 (R06a) QSFP-DD MSA revision 4.0, 8 x 50G and 4 x 100G QSFP MSA revision 2.0, 8 x 50G and 4 x 100G 400G DAC cables support Pluggable, MSA-compliant QSFP+ transceivers Pluggable, MSA-compliant SFP28 optical transceiver Pluggable, MSA-compliant SFP/SFP+ optical transceivers
Line rate	425/212.5/106.25 (single lambda)/103.125/53.125/41.25 Gbit/s, 100G SRBD, 25GE, 10GE LAN, 10GE WAN and 1GE OIF DCO Coherent OSFP & QSFP DD ZR and ZR+
400G ecosystem support	400/200GbE, FlexE and OTUCn and FlexO
Robust physical-layer validation	400GAUI lane-error generation and monitoring PCS lane mapping and monitoring capability Per-lane skew generation and measurement PCS error generation and monitoring per lane Full MDIO/I2C read/write access
Transceiver and cable validation	SFP, SFP+, SFP28, QSFP+, QSFP28, CFP8, QSFP56, QSFP-DD, OSFP and CFP2-DCO
iOptics	Optical-device I/O interface quick check Optical Tx power-level test Optical Rx signal-presence and level test Stress test Excessive skew test Temperature and power consumption monitoring Host and media loopback
Power measurement	Optical channel power measurement with color indicators per lane
Frequency measurements	Allow users to measure the received frequency per wavelength (in Hz) in the used of parallel optics
Frequency offset	Offsetting of the transmitted signal's clock on a selected interface, and monitoring
Transceiver non-blocking analysis	Enables a step-by-step monitoring of the transceiver boot-up sequence
BERT	BERT framed and unframed testing using different parameters different frame sizes, including EMIX
Service disruption time (SDT)	Service disruption time measurements based on no traffic, mode, with statistics including longest disruption time, shortest, last, average, count, total and pass/fail thresholds
Latency measurements in BERT	High-resolution delay measurements integrated in the BER with statistics including current, average, maximum, minimum, count, total and pass/fail thresholds
Error injection mode	Manual, rate and continuous (maximum rate)
Layer 2	MAC address and Ether type edition available Q-in-Q capability with the ability to go up to three layers of stacked VLANs
Layer 3/4	Source and destination IP address configuration available IP TOS/DSP configuration available UDP source and destination port configuration available
RFC 2544	Throughput, back-to-back, frame loss and high-resolution latency measurements according to RFC 2544; frame size: RFC-defined or user-configurable
EtherSAM	Simplified ITU-T Y.1564 test that performs service configuration and service performance tests using remote loopback or dual test set mode for bidirectional results
Traffic generation and monitoring	Traffic generation and shaping of up to 16 streams of Ethernet and IP traffic, including the simultaneous monitoring of throughput, frame loss, packet jitter, latency and out-of-sequence frames, including MAC flooding for source and destination MAC addresses
Breakout cable support	Verification of 2 x 100GE, 4 x 100GE, 2 x 200GE and 8 x 50GE breakout cables providing optical Tx/Rx power, L2/L3 traffic and BERT statistics per link
Smart loopback	Return Ethernet traffic to the local unit by swapping packet overhead up to layer 4
Rx frame-size analysis	< 64, 65 - 127, 128 - 255, 256 - 511, 512 - 1023, 1024-1518 and > 1518
Rx rate	Line utilization (%), Ethernet BW (Mbit/s), frame rate (frame/s), and frame count
Ethernet alarms	Link down, local fault detected, local fault received, remote fault, LOA
Ethernet errors	FCS, jabber, runt, undersize and oversize

**SUMMARY OF KEY FEATURES (CONTINUED)**

Higher layer error analysis	UDP checksum
PCS lane alarms and errors	LOS, LOC-lane, LOAML, excessive skew, Inv. Marker, Pre-FEC SYMB and Pre-FEC-bit
Skew insertion	Per-lane skew generation and measurement range 0 to 10550
PCS logical lane mapping	Manual and random
FEC	Generation and analysis of FEC correctable and uncorrectable errors, local and remote degraded SER monitoring
FEC statistics	Number of symbol errors per correctable codeword, number of pre-FEC symbol errors and bit statistics, codeword count (error-free and uncorrectable) and percentage
PAM4 histogram	Provides a graphic view from PAM4 eye diagram per lane, including PAM4 levels
Pre-emphasis	Pre-/main-/post- cursor, lower/upper eye and swing (%) options to improve electrical waveform
IP tools	Performs ping and traceroute functions
IPv4 and IPv6 testing	Performs the following tests up to 400G over IPV4 and IPv6, RFC 2544, BERT, traffic generation and monitoring, EtherSAM, ping and traceroute
Advanced filtering	Configure up to 10 filters, each with four fields that can be combined with AND/OR/NOT operations; a mask is also provided for each field value with IPv4 or IPv6 capabilities
Remote access	Supported via EXFO Remote ToolBox, Remote Desktop, VNC and EXFO Multilink for multiuser support
Automation	Wide range of commands available per application to allow test automation
Reporting	Test results are included in a report that can be generated in different formats: pdf, html and json

**UNFRAMED BER TEST**

Pattern configuration	16 unframed 400GAUI-16 lanes, 16 unframed 400GAUI-8 lanes, 8 unframed 400GAUI-8 lanes, 4 unframed 200GAUI-4 lanes and 8 unframed 200GAUI-4 lanes
PRBS patterns per lane	Allow users to configure different PRBS patterns on different 400GAUI lanes
Patterns	PRBS 2E31-1, PRBS 2E23-1, PRBS31Q, PRBS13Q, SSPRQ capability to invert patterns
Error measurement	Mismatch 0, mismatch 1, bit error and pattern loss per 400GAUI/200GAUI lane displayed in seconds, count and rate
Alarm injection	Capabilities to inject pattern loss and LOS per 400GAUI/200GAUI lane continuously

**Flex ETHERNET**

Compliance	Compliant with OIF, FlexE 2.0
Multi-interface support	Four QSFP28 ports, one port QSFP-DD or OSFP port to configure FlexE traffic up to 400GE
RS-FEC support	RS-FEC capabilities per port
Skew monitoring	Graphical skew monitoring per port
Skew insertion	Per-port skew generation and measurement range 0 to 10000 ns
PHY number	FlexE PHY number per port edition available
Group number	FlexE group number edition available
Client	Client ID and Mac address edition available per client
Calendar type	Calendar A/B configuration and monitoring
Calendar edition	Graphical calendar configuration per slot/client/clients for FlexE bonding, sub-rate and channelization
Clients available	Different client configuration included 5GE, 10GE, 25GE, 40GE, 50GE, 100GE, 150GE, 200GE, 250GE, 300GE, 350GE and 400GE
Ports capacity	Display the calendar used, unused and assigned capacity in Gbit/s
Client statistics	Size, Tx and Rx rate in Gbit/s, frame count
BERT	Selectable FlexE client bit error rate analysis using a specific pattern
BER error injection	Manual, rate and continuous (maximum rate)
Error/alarms monitoring and injection	Per port FlexE PHY, per FlexE group and per client
FlexE overhead	Display a detail overview from block 1 to 8 per frame from the FlexE overhead for Tx and Rx
FlexE G.mtn path OAM (pre-standard version)	Support of CC function status, connectivity verification, bidirectional delay measurement and CS type monitoring

TRANSPORT TESTING		
OTN interfaces	Standards compliance	ITU-T G.709, G.798, G.872 and ITU-T G series Supplement 43
	Line rates	OTU3 (43 Gbit/s), OTU3e1 (44.57 Gbit/s), OTU3e2 (44.58 Gbit/s), OTU4 (111.81 Gbit/s)
	Power measurement	Optical channel power measurement with color indicators
	Frequency measurement	Clock frequency measurements displayed in Hz
	Frequency offset	Offsetting of the transmitted signal's clock on a selected interface, and monitoring to exercise clock recovery circuitry on network elements
OTL layer	Errors per lane	Invalid marker, FAS
	Alarms per lane	OOF, LOF, LOR, OOR, excessive skew
	Global alarm	LOL
OTU layer	Errors	OTU-FAS, OTU-MFAS, OTU-BEI, OTU-BIP-8
	Alarms	LOF, OOF, LOM, OOM, OTU-TIM, OTU-BDI, OTU-IAE, OTU-BIAE, OTU-AIS
	Traces alarms	64-byte trail trace identifier (TTI) as defined in ITU-T G.709
ODU layer	Errors	ODU-BIP-8, ODU-BEI
	Alarms	ODU-AIS, ODU-OCI, ODU-LCK, ODU-TIM, ODU-BDI, ODU-FSF, ODU-BSF, ODU-FSD, ODU-BSD, ODU-LOFLOM
	Traces	64-byte trail trace identifier (TTI) as defined in ITU-T G.709
	FTFL	Fault type and fault location byte; as defined in ITU-T G.709 standard
ODU TCM layer	Errors	TCMi-BIP-8, TCMi-BEI (i = 1 to 6)
	Alarms	TCMi-LTC, TCMi-TIM, TCMi-BDI, TCMi-IAE, TCMi-BIAE
	Traces	64-byte trail trace identifier (TTI) as defined in ITU-T G.709
OPU layer	Alarms	OPU-PLM, OPU-CSF, OPU-AIS, OPU-MSIM, OPU LOOMFI, OOMFI, OMFI <sup>a</sup>
	Payload type	Generates and displays received PT value
Forward error correction (FEC)	Errors	Generation and analysis of FEC correctable and uncorrectable errors
Ethernet mapping over OTN	40G and 100G Ethernet mapping over OTU3 and OTU4, respectively, using GMP	
	40G transcoding capability with alarms, errors and statistics	
	GMP alarms, errors and statistics	
	GigE mapping into ODU0 using GFP-T, 10 GigE mapping into ODU2 using GFP-F, direct 10 GigE mappings into ODU1e and ODU2e in different ODU multiplexing structures	
	40GE into OTU3 into OTU4	
	Flexibility to map up to a 10G Ethernet client signal into ODUflex	
40GE transcoding	Errors	Invalid flag, POS violation, MSEQ violation, PCS-BIP-8 mask per lane, PCS-BIP-8 per lane, OTN-BIP-8 per lane, SEQ violation
	Alarms	LOBL 1027B, Hi-BER 1027B, LOAML 1027B
GMP	Errors	Cm CRC-8, CnD CRC-5
	Alarms	GMP OOS <sup>a</sup>
	Statistics	Cm minimum/maximum values and CnD minimum/maximum values for both GMP Tx and Rx
ODU3/ODU4 multiplexing	Mappings	ODU13, ODU23, ODU123, ODU03, ODU013, ODU0123, ODU04, ODU014, ODU134, ODU24, ODU234, ODU34, ODU14, ODU01234, ODU0124, ODU024, ODU034, ODU1e4, ODUflex24, ODU2e4 and ODU124, ODU1234 with PRBS pattern and GigE, 10 GigE, 40 GigE and 100 GigE client mappings into OPU payloads
	Alarms	ODU34, ODU14, ODU01234, ODU0124, ODU024, ODU034, ODU1e4, ODUflex24, ODU2e4 and ODU124, ODU1234 with PRBS pattern and GigE and 10 GigE client mappings into OPU payloads
	Clients	GigE, 10 GigE, 40 GigE and 100 GigE client mappings into OPU payloads
	ODU0	ODU0 (1.25 Gbit/s) container with Gigabit Ethernet and PRBS pattern
	ODUflex	ODUflex at ODU3 and ODU4 rates with full flexibility to configure the required bandwidth based on n x 1.25 Gbit/s tributary time slots with a PRBS pattern into the ODUflex payload
GFP-F/T	Errors	GFP-cHEC-CORR, GFP-cHEC-UNCORR, GFP-tHEC-CORR, GFP-tHEC-UNCORR, GFP-eHEC-CORR, GFP-eHEC-UNCORR, GFP-pFCS
	Alarms	GFP-LFD, GFP-EXM, GFP-UPM, GFP-DCI, GFP-FDI, GFP-RDI, GFP-LOCS, GFP-LOCCS, GFP-reserved CMF
	Frame type statistics	Client data, client management, idle, reserved PTI, reserved PLI, invalid, discarded
	Rx mismatch	PFI, EXI, UPI, CID
	GFP-T superblock statistics	Valid, invalid and total

a. Alarm analysis only.

OTUCn/FlexO	
Compliance	ITU-T G.709, ITU-T G.709.1 and ITU-T G.798
Multi-interface support	FOIC (QSFP28) ports available testing up to 419G
RS-FEC support	RS FEC error monitoring and injection per PHY
FlexO Instance ID	ID number selection, monitoring and mismatch detection
FlexO Group ID	Group ID number selection, monitoring and mismatch detection
FOIC	Supports FOIC per lane alignment marker monitoring and error injection
Skew	Skew alarm monitoring on PHYs and skew values reported per FlexO instance
BERT	Bit error analysis using PRBS31 supporting alarm/error monitoring and injection
BER error injection	Manual, rate and continuous (maximum rate)
OTUCn Frame	OTUC1, OTUC2, OTUC3 and OTUC4 level alarms/error monitoring and injection
ODUCn/ODUk	ODUC1, ODUK2, ODUK3 and ODUK4 level alarms/error monitoring and injection
OTUCn	Trace configuration and monitoring
ODUCn/ODUk	Trace/payload type configuration and monitoring

COHERENT OPTICS	
Compliance	OIF 400ZR, IEEE 802.3cw, OpenZR+, OpenROADM
Tx power	Optical power Tx transceiver configuration
Wavelength	Transceiver grid configuration
Optical metrics	Test set displays the following optical metrics CD (ps/nm), CFO (MHz), DGD (ps), OSNR (dB), PDL (dB), SOPCR (Krad/s), SOPMD (ps <sup>2</sup> )
Client configuration	Ethernet client L2/3 and L4 configuration
Ethernet frame	Client Ethernet frame configuration fixed or EMIX
Ethernet client BERT	Bit error analysis using PRBS31 supporting alarm/error monitoring and injection
FED	User can enable FEC excessive degrade alarm monitoring
FDD	User can enable FEC detected degrade alarm monitoring
FEC alarms	FED and FDD alarms monitoring
FEC error monitoring	FEC-UNCOR-FR and FEC-COR-BITS monitoring
Ethernet alarms	Link down, L Fault Det, L Fault Rcd, Remote fault LOA alarms
Ethernet errors	66B Block, FEC-UNCOR-FR, FEC-COR-BITS, FCS, Jabber, runt and undersize errors
Error and alarm injection	User can inject Interface, Ethernet, PCS and BERT errors and alarms
DCO Tx alarms	Tx LOA, Tx OOA, Tx CMU LOL, Tx RefClk LOL, Tx Deskew LOL, Tx FIFO
DCO Rx alarms	Rx LOF, Rx LOM, Rx Demod LOL, Rx CDC LOL, Rx LOA, Rx OOA, Rx Deskew LOL, Rx FIFO

**EXFO headquarters** T +1 418 683-0211 **Toll-free** +1 800 663-3936 (USA and Canada)

EXFO serves over 2000 customers in more than 100 countries. To find your local office contact details, please go to [www.EXFO.com/contact](http://www.EXFO.com/contact).

For the most recent patent marking information, please visit [www.EXFO.com/patent](http://www.EXFO.com/patent). EXFO is certified ISO 9001 and attests to the quality of these products. EXFO has made every effort to ensure that the information contained in this specification sheet is accurate. However, we accept no responsibility for any errors or omissions, and we reserve the right to modify design, characteristics and products at any time without obligation. Units of measurement in this document conform to SI standards and practices. In addition, all of EXFO's manufactured products are compliant with the European Union's WEEE directive. For more information, please visit [www.EXFO.com/recycle](http://www.EXFO.com/recycle). **Contact EXFO for prices and availability or to obtain the phone number of your local EXFO distributor.**

For the most recent version of this spec sheet, please go to [www.EXFO.com/specs](http://www.EXFO.com/specs).

In case of discrepancy, the web version takes precedence over any printed literature.