

# Mass Fusion Splicer **90R** kit series

## Replaceable V-groove

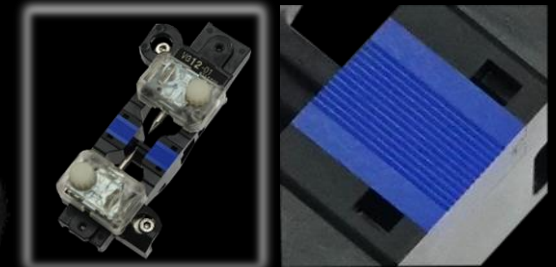

*250µm fiber spacing*

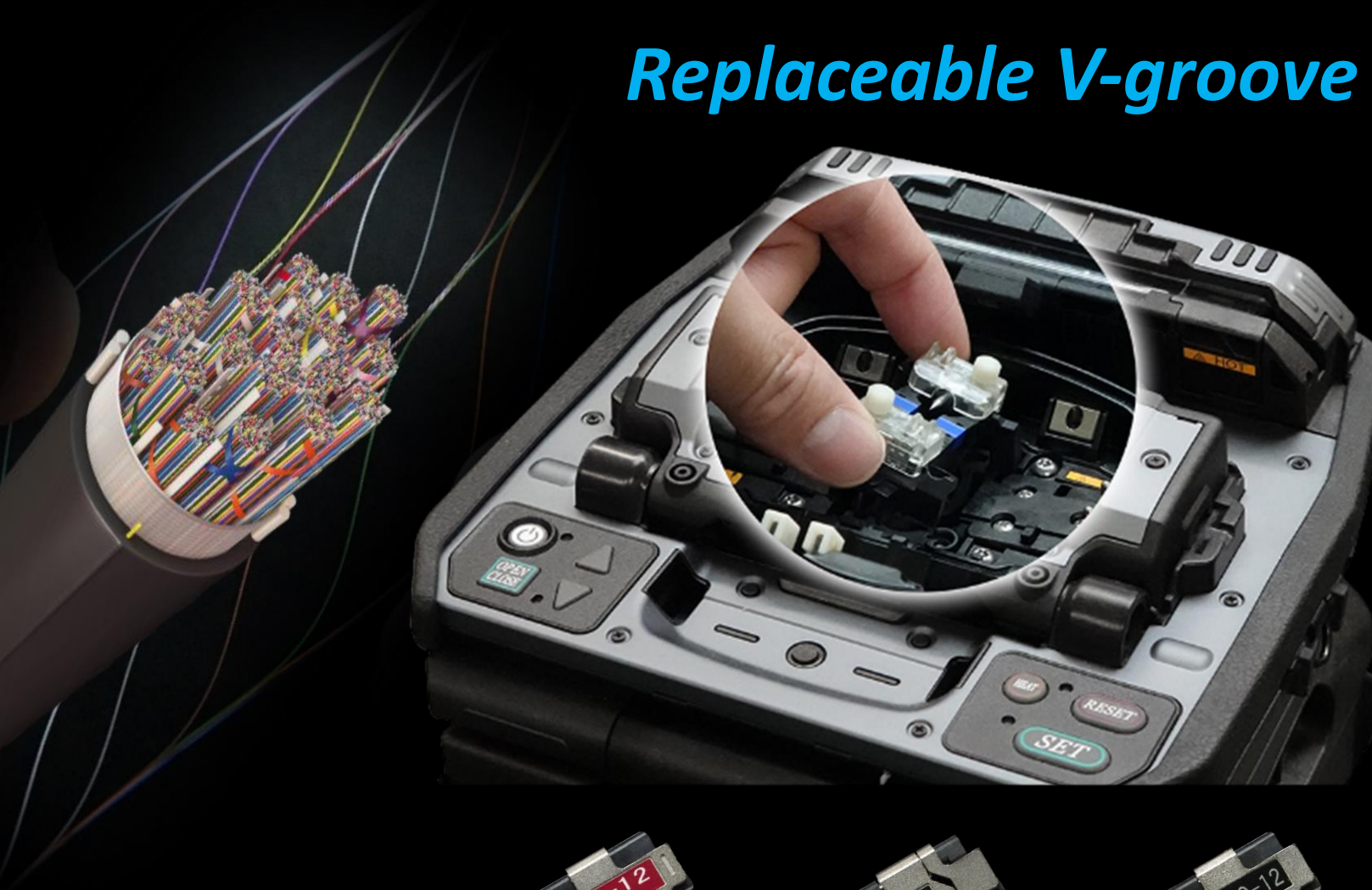
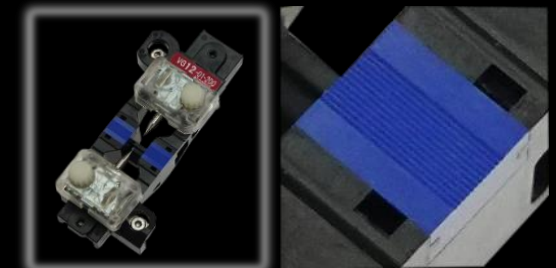

*200µm fiber spacing*

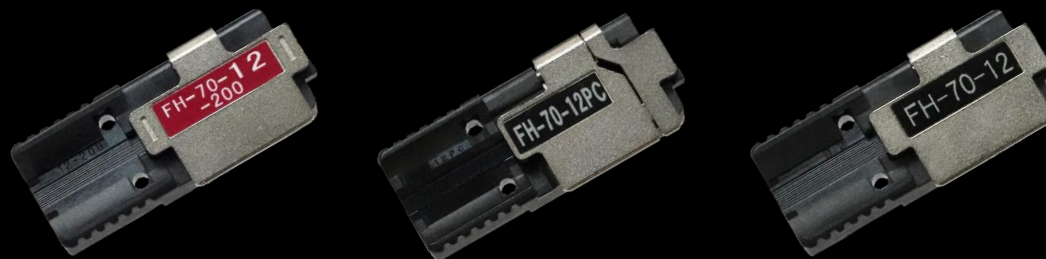

# Cutting-edge Feature

## 1. Replaceable 200 $\mu$ m/250 $\mu$ m spacing V-groove

The 90R features an easily replaceable V-groove system, which allows customers to install and remove the V-groove very quickly. Almost all ribbon cables that have already been installed contain ribbons with fibers that have 250 $\mu$ m coating and therefore a 250 $\mu$ m fiber-to-fiber spacing. But with increasing cable densities, cable installations with 200 $\mu$ m coated fibers at a 200 $\mu$ m spacing is increasing. The 90R user can splice various types (and combination) of ribbon fiber by switching the V-groove spacing between 200 $\mu$ m and 250 $\mu$ m according to the type of optical fiber to be spliced.

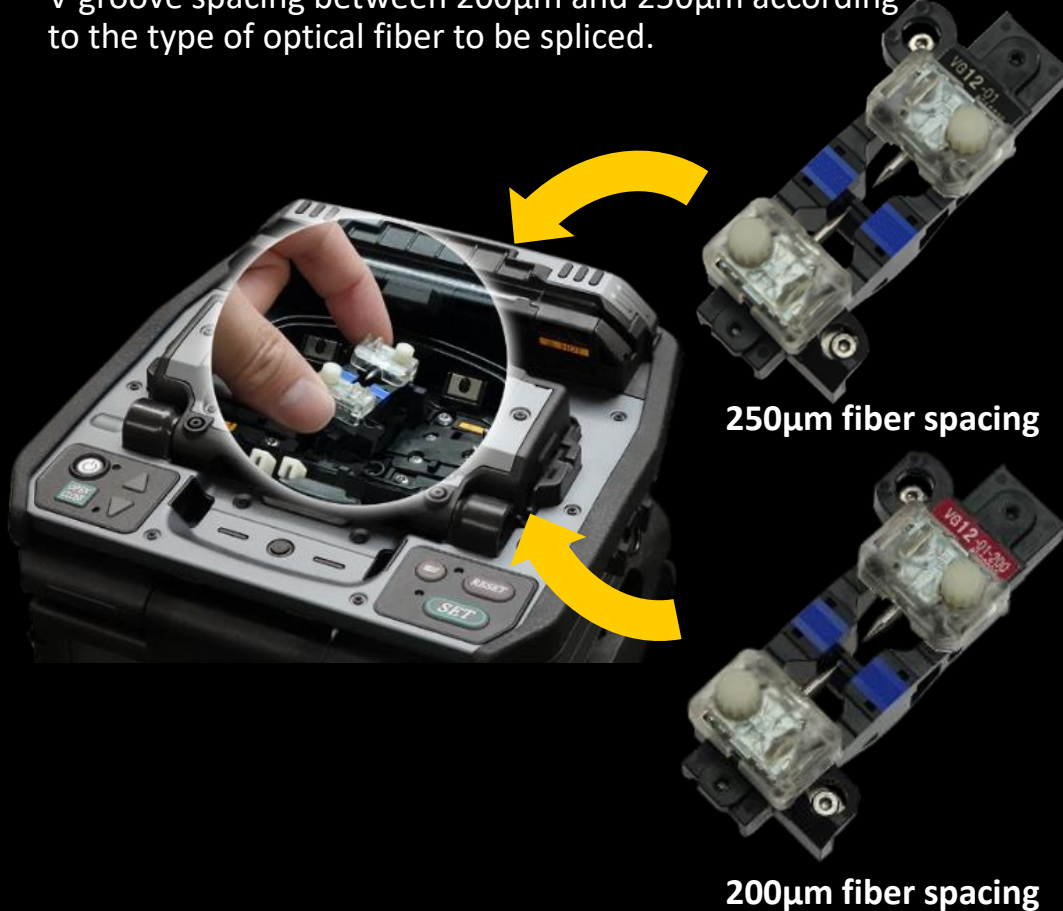

## 2. Minimizing the downtime on the field

Accumulation of dust and melted glass on the V-groove is one of the causes of high splice loss during fusion splicing. The 90R includes a spare set of 12 fiber V-grooves with electrodes installed and ready to splice as part of the standard package. These spare V-grooves are field replaceable, so user downtime is minimized. The electrodes are pre-stabilized, so electrode stabilization is not required.

Glass deposition on Electrode

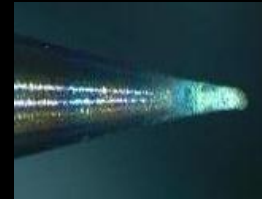

Glass deposition on V-groove



Cause of Large Fiber Offset

No.	Gap [μm]	Offset [μm]	Cleave L	Cleave R
1	68	0.9	1.4°	1.9°
2	63	0.3	0.5°	1.1°
3	55	1.3	0.7°	0.9°
4	54	5.2	1.7°	1.2°
5	54	0.4	1.3°	0.4°
6	62	1.1	0.4°	0.7°
7	48	1.2	1.9°	0.3°
8	48	2.7	1.0°	1.5°
9	48	0.8	1.9°	0.1°
10	43	6.7	0.9°	0.3°
11	42	0.7	0.4°	1.8°
12	40	2.8	2.0°	0.5°

Glass deposited V-groove and electrodes

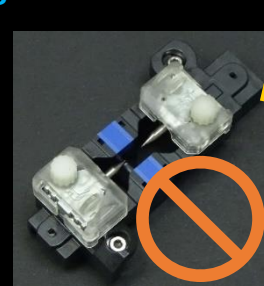

Remove

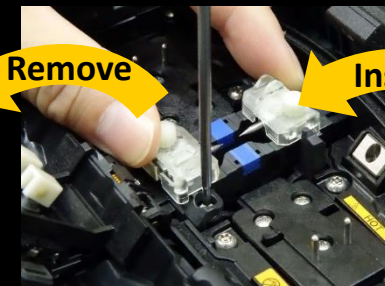

Install

Spare V-groove with stabilized electrodes

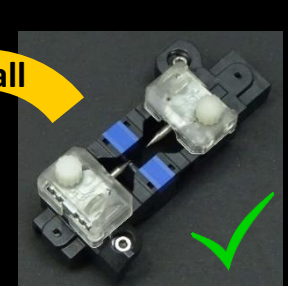

### 3. Universal Fiber Holder

The FH-70-12 fiber holder is compatible with many types of 12 fiber ribbon, such as 0.3mm or 0.4mm thick encapsulated ribbons and 200µm or 250µm coated Spider Web Ribbon (SWR). The 250µm spacing V-grooves in the FH-70-12 fiber holder simplify SWR loading and ribbon preparation.

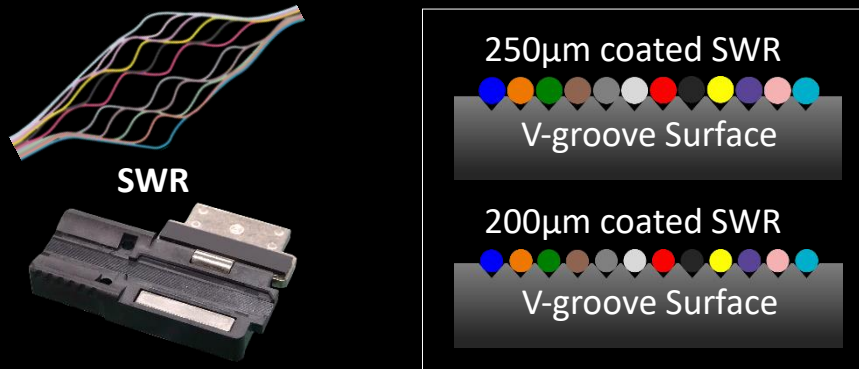

FH-70-12

### 4. Pitch Conversion Fiber Holder

The pitch conversion fiber holder, FH-70-12PC, enables pitch conversion of individual 200µm coated fibers from a 200µm to 250µm spacing. It also enables many ribbons with 200µm spacing to be converted to 250µm spacing so they can be loaded into the standard 90R 250µm V-groove.

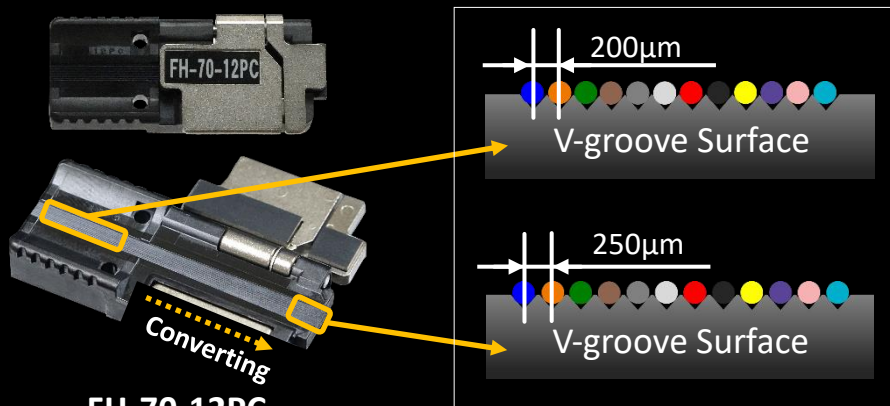

FH-70-12PC

### 5. Ribbonizing Tool

The RT-02 is a tool which enables quick and easy ribbonization of 12 individual fibers into a temporary ribbon which can be spliced using a 90R. No glue or adhesive is required when using this ribbonizing tool since the arranged fibers are immediately loaded into the fiber holder. The RT-02 doesn't require the user to insert the fibers in the color code sequence, which is necessary with other ribbon arrangement tools. The user can choose any fiber at random and place it in the correct slot by referring to the color code label on the tool. The RS-02 is applicable to ribbonize both 200µm and 250µm coated fibers. It's also capable of ribbonizing 200µm coated fibers into 250µm spacing ribbon using the FH-70-12PC pitch conversion fiber holder or a 200µm spacing using the "Red Label" FH-70-12-200 (200µm spacing) fiber holder.

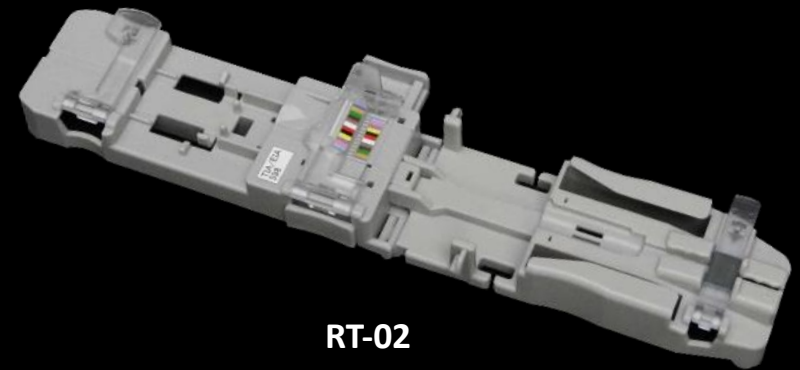



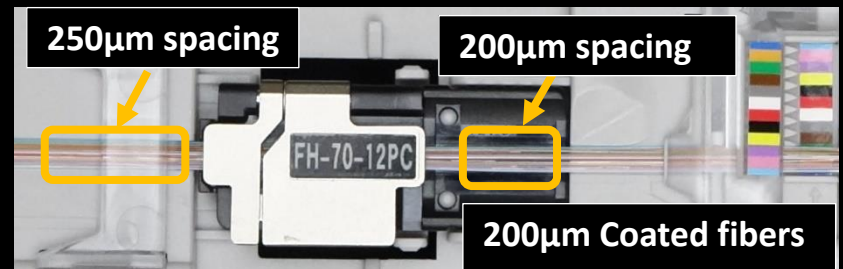





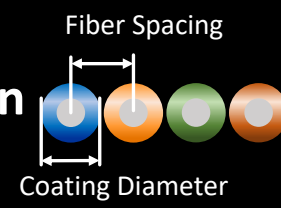

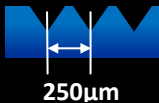

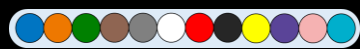
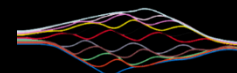

RT-02

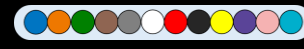

Ribbonizing 200µm coated fiber at a 250µm pitch

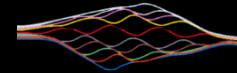
# 6. 90R12 Accessories Enable Splicing any Combination of 250um and 200um Ribbon

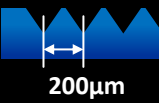

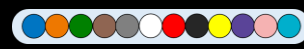
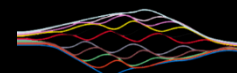
Replaceable V-groove	Fiber Holder	Coating Diameter	Fiber Spacing	Ribbon Structure	Ribbonizing tool
 <p>VG12-01 250μm</p>	 <p>FH-70-12</p>	250μm	Not fixed	 <p>Single fibers</p>	 <p>RT-02/FAT-04</p>
		200μm	250μm	 <p>Encapsulated ribbon</p>  <p>Flexible Ribbon</p>	Not fixed
 <p>FH-70-12PC</p>	200μm	Not fixed	 <p>Single fibers</p>	 <p>RT-02</p>	
		200μm	 <p>Encapsulated ribbon</p>  <p>Single fibers</p>		
		250μm	 <p>Flexible Ribbon</p>  <p>Single fibers</p>		
 <p>VG12-01-200 200μm</p>	 <p>FH-70-12-200</p>	200μm	Not fixed	 <p>Single fibers</p>	Not fixed
			200μm	 <p>Encapsulated ribbon</p>  <p>Flexible Ribbon</p>	

# Well-developed operability

## 1. Carrying Case

There are multiple ways to utilize the 90R carrying case. The 90R is ready to use just by opening the case, but it is also possible to use the 90R on top of the carrying case or only with the work tray depending on the work environment.

### Ready to use



Large storage space under work tray

Lid of carrying case becomes a work tray

## 2. Work Tray

The work tray has many functions. There are two drawers for storage which are large enough to store tools or battery packs. Also, the work tray can be divided in two, so it is configurable to fit your work space.

### Separable Work Tray

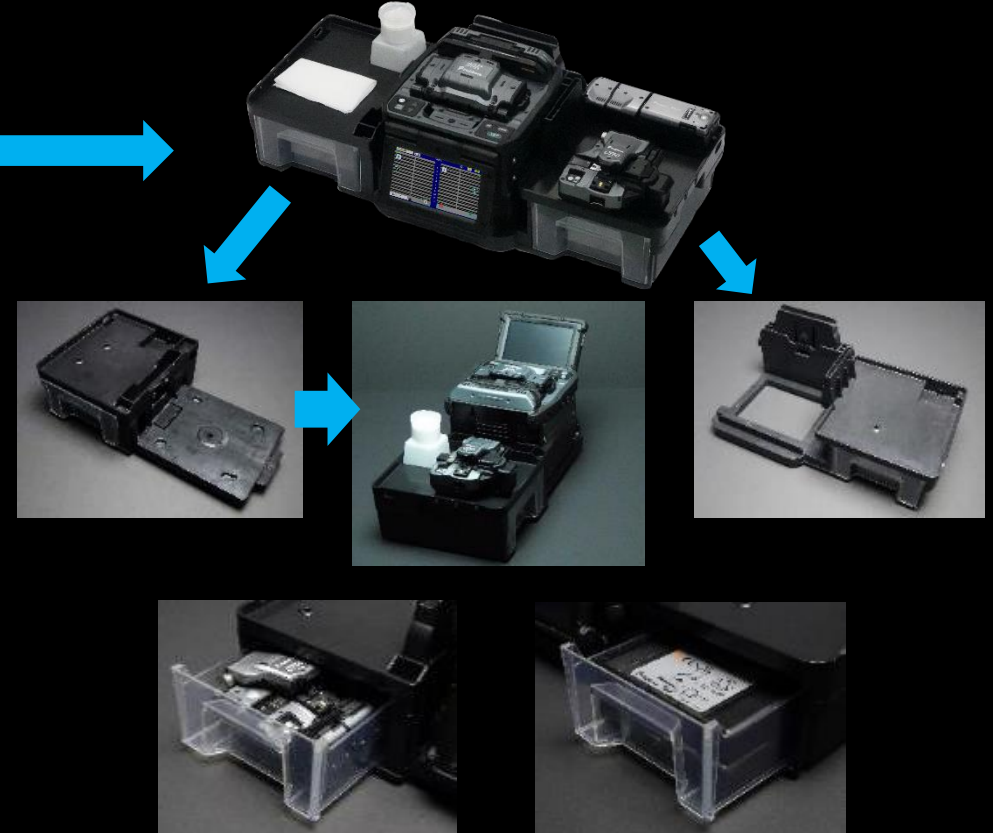

Cleaver & Stripper

Battery packs

Plenty of space in work tray

# Active Fusion Control Technology

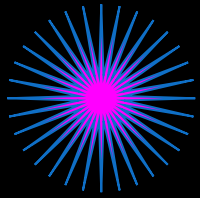

## ACTIVE FUSION

CONTROL TECHNOLOGY

The 90R features ACTIVE FUSION CONTROL TECHNOLOGY which has two key components. This function enables stable fusion splicing with a wide variety of optical fibers and field conditions.

### 1. Active Fusion control by Real-time

The 90R mass fusion splicer uses a wide electrode gap and heats the ribbon fibers uniformly. It features real-time fusion power control by analyzing the fiber's brightness intensity during the splicing arc. Therefore, it can splice the fiber by appropriate fusion parameters.

The 90R does not have active core alignment mechanisms, however, during the fusion, fiber surface tension effects minimize preexisting offsets.

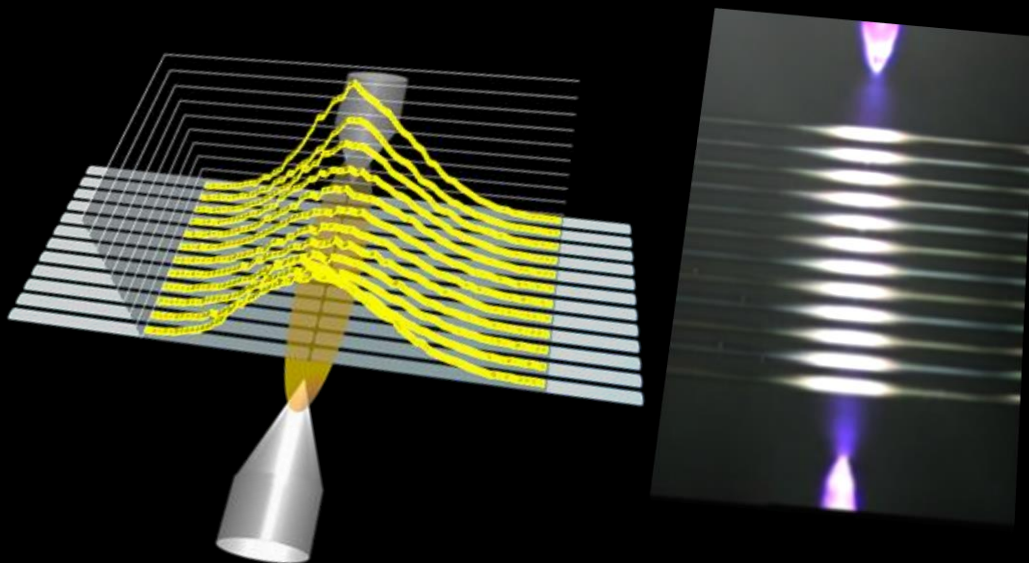

### 2. Active Fusion control by V-groove and fiber count

The 90R automatically determines the appropriate fusion splicing parameters according to the ribbon fiber count and the installed V-groove spacing.

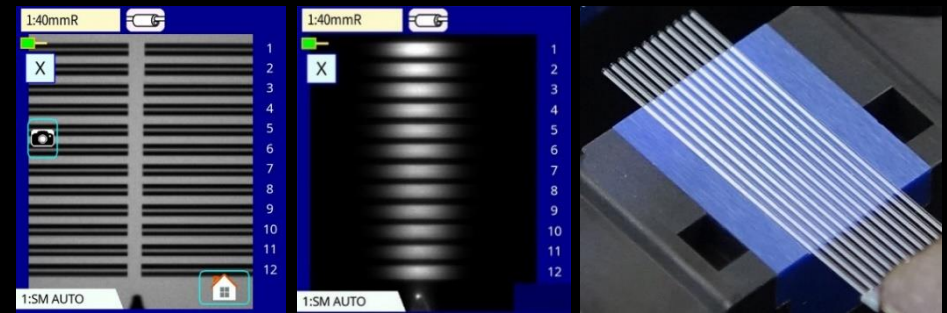

250µm fiber spacing / 12-fiber ribbon

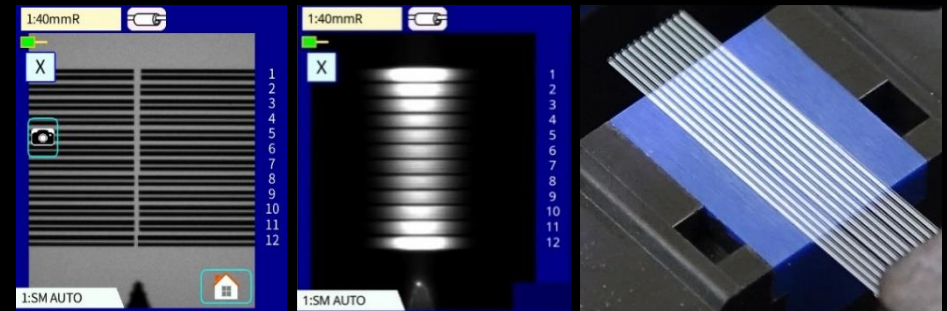

200µm fiber spacing / 12-fiber ribbon



Single fiber

# Active Blade Management Technology

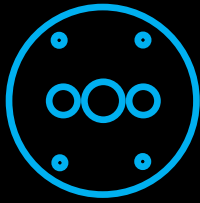

**ACTIVE BLADE**  
MANAGEMENT TECHNOLOGY

## 1. Active Blade rotation by motor

The 90R and CT50 fiber cleaver are provided with wireless data connectivity. This capability allows automatic cleaver blade rotation when the 90R judges the blade is worn. The 90R can be connected to two CT50 cleavers simultaneously.



Motorized blade

No.	Gap (μm)	Offset (μm)	Cleave
1	62	0.9	0.8° 6.7%
2	65	1.6	0.8° 0.1%
3	57	1.2	0.7° 0.1%
4	65	0.7	0.6° 5.2%
5	60	1.6	0.4° 0.5%
6	46	0.3	0.2° 0.0%
7	46	0.2	0.5° 0.3%
8	55	1.7	0.8° 0.5%
9	50	1.7	0.1° 0.9%
10	56	1.7	0.8° 0.6%
11	49	1.9	0.6° 0.9%
12	41	1.2	0.2° 0.8%

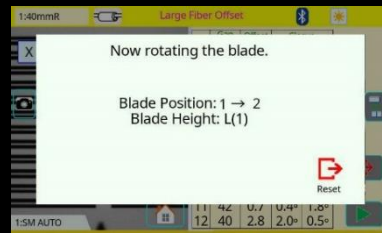

## 2. Active Blade life management

The 90R displays the remaining blade life and informs the user when a blade height change, position change, or new blade is required.

No.1	No.2	No.3	No.4	No.5	No.6	No.7	No.8
M(0)	0	0	0	0	0	0	0
M(2)	0	0	0	0	0	0	0
L(0)	1014	1041	1175	1167	1522	1134	1530
L(1)	1439	1439	1439	1439	1439	1439	1439
M(0)	0	0	0	0	0	0	0
M(2)	0	0	0	0	0	0	0
L(0)	1185	1218	1025	1407	1338	1484	1259
L(1)	1060	1060	1060	1060	1060	1060	1060

Blade Height : L(1)  
Recommended Position  
Reset

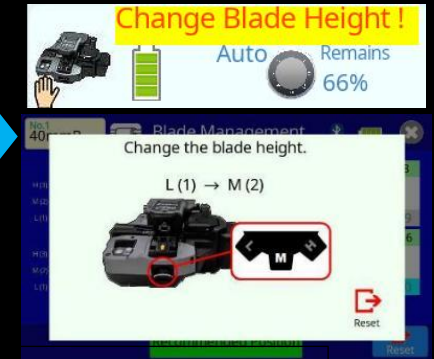

## 3. Stripping Condition Control

When the user changes the splice mode, e.g. from 12 fiber ribbon splice mode to SWR fiber splice mode, a wireless command from the splicer automatically changes the ribbon stripper RS03 heating temperature and time.



# Standard Package

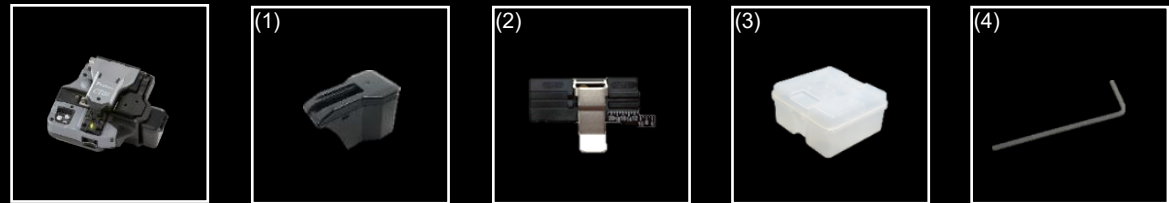
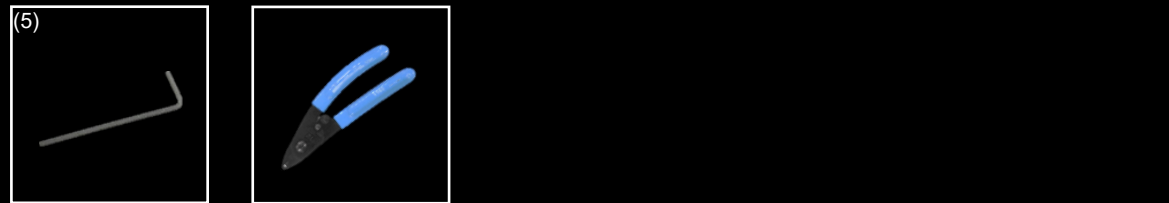
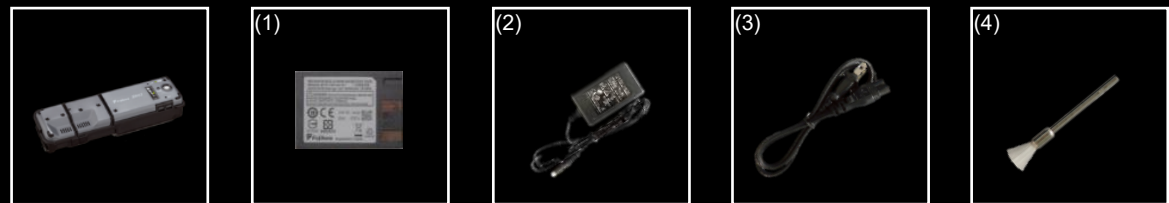
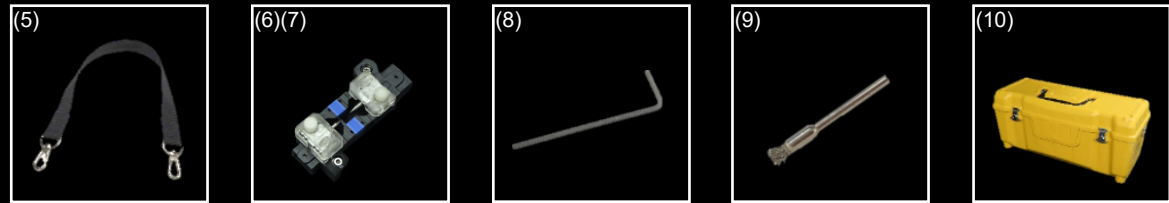

## 90R12 Standard package

Item	Model	Qty
Mass Fusion Splicer	90R12	1 pc
(1) Battery Pack *	BTR-15	1 pc
(2) AC Adapter	ADC-20	1 pc
(3) AC Power Cord	ACC-14, 15, 16, 17 or 18	1 pc
(4) USB Cable	USB-01	1 pc
(5) Fusion Splicer Strap	ST-02	1 pc
(6) Electrodes, on spare V-groove	ELCT2-16B	1 pair
(7) 12 fiber V-groove, spare	VG12-01, 250 to 255µm spacing	1 pc
(8) Hexagonal Wrench	HEX-01	1 pc
(9) V-groove Cleaning Brush	VCB-01	1 pc
(10) Carrying Case	CC-39	1 pc
(11) Work Tray Left	WT-09L	1 pc
(12) Work Tray Right	WT-09R	1 pc
(13) Work Tray J-Plate	JP-09	1 pc
(14) Tripod Screw	TS-03	2 pcs
(15) Carrying Case Strap	ST-03	1 pc
(16) Alcohol Dispenser	AP-02	1 pc
(17) Quick Reference Guide	ORG-03-E	1 pc
Ribbon Fiber Stripper	RS03	1 pc
(1) Battery Pack *	BTR-12A	1 pc
(2) AC Adapter	ADC-09A	1 pc
(3) AC Power Cord	ACC-08, 09, 10, 11 or 12	1 pc
(4) Blade Cleaning Brush	BRS-02	1 pc
(5) Hexagonal Wrench	HEX-01	1 pc
Single Fiber Stripper	SS03 or SS01	1 pc
Optical Fiber Cleaver	CTS0	1 pc
(1) Fiber Scrap Collector	FDB-05	1 pc
(2) Fiber Setting Plate	AD-10-M24	1 pc
(3) Case	CC-37	1 pc
(4) Hexagonal Wrench	HEX-01	1 pc

\* Please follow IATA regulation when shipping the battery by air.



# Specifications

## 90R12 Specifications

## 90R12 Options



Item		Specification	
Fiber alignment method		Self cladding alignment with surface melting tension	
Fiber count can be spliced		90R12 : Up to 12 fiber ribbon	
Applicable fiber	Fiber type	Single mode optical fiber	
	Cladding dia.	Multi mode optical fiber Approx.125μm	
Applicable coating	Fiber holder	Coating shape : Refer to options Cleave length : Approx.10mm	
	Fiber splice performance	Splice loss *1 ITU-T G.652 : Avg. 0.05dB ITU-T G.651 : Avg. 0.02dB ITU-T G.653 : Avg. 0.08dB ITU-T G.655 : Avg. 0.08dB ITU-T G.657 : Avg. 0.05dB	
Applicable protection sleeve	Sleeve type	SM FAST mode : Avg. 16 to 17sec. SM AUTO mode : Avg. 19 to 20sec.	
		Sleeve length	Heat shrinkable sleeve Max. 66mm
		Sleeve dia.	Max. 6.0mm before shrinking
Sleeve heat performance	Heat time *3	40mm FP-05 mode : Avg. 38 to 40sec. 40mm FP-04T FAST mode : Avg. 17 to 19sec. Single 60mm mode : Avg. 13 to 15sec.	
		Fiber tensile test force	Approx. 2.0N
Electrode life *4		Approx. 1500 splices	
Physical description	Dimensions W	Approx.170mm without projection	
	Dimensions D	Approx.173mm without projection	
	Dimensions H	Approx.150mm without projection	
	Weight	Approx. 2.6kg including battery	
Environmental condition	Temperature	Operate : -10 to 50 degreeC Storage : -40 to 80 degreeC	
		Humidity	Operate : 0 to 95%RH non-condensing Storage : 0 to 95%RH non-condensing
	Altitude	Max. 3700m	
AC adaptor	Input	AC100 to 240V, 50/60Hz, Max. 1.5A	
Battery pack	Type	Rechargeable Lithium Ion	
	Output	Approx. DC14.4V, 6380mAh	
	Capacity *5	Approx. 165 splice and heat cycles	
	Temperature	Recharge : 0 to 40 degreeC Long Term Storage : -20 to 30 degreeC	
	Battery life *6	Approx. 500 recharge cycles	
Display	LCD monitor	TFT 4.9 inches with touch screen	
	Magnification	Approx. 20X : 12 ribbon to 60X : single	
illumination	V-grooves	LED lamp	
Interface	PC	USB2.0 Mini B type	
	External LED lamp	USB2.0 A type Approx. DC5V, 500mA	
	Ribbon Stripper	Mini DIN 6pin DC12V, Max. 1A	
	Wireless *7	Bluetooth 4.1 LE	
Data storage	Splice mode	100 splice modes	
	Heat mode	30 heat modes	
	Splice result	10000 splices	
	Splice image	100 images	
Screw hole for tripod		1/4-20UNC	
Other features	Automatic functions	Splice mode select by fiber count analysis Fusion power calibration Wind protector : open and close Heater lid : open and close Heater clamp : open and close	
		Reference guide	Video and PDF file stored in splicer
		Electrode	Replaceable without tool

Item	Model	Remark
V-groove	VG12-01-200	12 fiber ribbon, 200 to 210μm spacing
	FH-70-200	200μm coating diameter
	FH-70-250	250μm coating diameter
	FH-70-900	900μm coating diameter
	FH-70-2	2 fiber ribbon
	FH-70-4	4 fiber ribbon
	FH-70-8	8 fiber ribbon
	FH-70-10	10 fiber ribbon
	FH-70-12	12 fiber ribbon
	FH-70-12PC	Pitch conversion for 12 fiber ribbon
	FH-70-12-200	12 fiber ribbon, 200 to 210μm spacing
	FH-FC-20	900μm in 2mm diameter cable
FH-FC-30	900μm in 3mm diameter cable	
FH-60-LT900	900μm loose buffer cable	
DC Adapter	DCA-03	Connect AC adapter not through battery
DC power cord	DCC-20	Car cigar socket to BTR-15/DCA-03
	DCC-21	Car battery to BTR-15/DCA-03
	DCC-11	Splicer to ribbon stripper
Ribbonizing Tool	FAT-04	2 to 16 fibers, 250μm diameter
Transfer Clamp	RT-02	2 to 12 fibers, 200 to 250μm diameter
J-Plate	CLAMP-DC-12	Transferring drop cable on work tray
	JP-10	Attaching to splicer, not to work tray
Protection sleeve	JP-10-FC	JP-10 with fiber clamps
	FP-04(T)	40mm, up to 8 fiber ribbon
	FP-05	40mm, up to 12 fiber ribbon

### Notes

- \*1 Measured with a cut-back method relevant to ITU-T and IEC standard after splicing Fujikura identical fibers. The average splice loss changes depending on the environmental condition and fiber characteristics.
- \*2 Measured at room temperature. The definition of splice time is from the fiber image appeared in LCD monitor to the estimated loss displayed. The average splice time changes depending on the environmental conditions, fiber type, and fiber characteristics.
- \*3 Measured at room temperature with the AC adapter. The heat time is defined from the start beep sound to the finish beep sound. The average heat time changes depending on the environmental conditions, sleeve type and battery pack condition.
- \*4 The electrode life changes depending on the environmental conditions, fiber type and splice modes.
- \*5 Test condition
  - (1) 12 fiber ribbon : Splice and heat time : 2 minutes cycle with FP-05 sleeve
  - (2) Using the splicer power save settings
  - (3) Using a not degraded battery
  - (4) At room temperature
  - (5) Without accessories ,RS03 etc., that use the power supply of the fusion splicer
 The battery capacity changes when testing with different conditions from the above.
- \*6 The battery capacity decreases to a half after approx. 500 discharge and recharge cycles. The battery life is shortened further when using outside of the storage temperature range, operating temperature range, if completely discharged by storing for a long time without recharging.
- \*7 Bluetooth® mark and logos are the registered trademarks of Bluetooth SIG, Inc.

# Specifications



## CT50 Specifications

Item		Specification
Applicable fiber	Fiber type	Single mode optical fiber
		Multi mode optical fiber
	Fiber count	Up to 16 fiber ribbon
	Cladding dia.	Approx. 125µm
Applicable coating	Fiber setting plate	AD-10-M24 : Max. 900µm coating diameter
	Fiber holder	AD-50 : Max. 3mm coating diameter Coating shape : Refer to splicer options
Cleave length	Fiber setting plate	AD-10-M24 : 5 to 20mm *1 AD-50 *C.D. : coating diameter C.D. = 250µm or less : 5 to 20mm *1 250µm < C.D. < =900µm : 10 to 20mm 900µm < C.D. < =3mm : 14 to 20mm
	Fiber holder	Approx. 10mm
Cleave angle *2	Single fiber	Avg. 0.3 to 0.9 degrees
	Fiber ribbon	Avg. 0.3 to 1.2 degrees
Blade life *3		Approx. 60000 fiber cleaves
Physical description	Dimensions W	Approx. 117mm without projection *4
	Dimensions D	Approx. 94mm without projection *4
	Dimensions H	Approx. 59mm without projection *4
	Weight	Approx. 306g including battery and AD-10-M24
Environmental condition	Temperature	Operate : -10 to 50 degreeC Storage : -40 to 80 degreeC
	Humidity	Operate : 0 to 95%RH non-condensing Storage : 0 to 95%RH non-condensing
Battery		2 pieces of LR03, AAA dry battery
Wireless interface *5		Bluetooth 4.1 LE
Screw hole for tripod		1/4-20UNC
Other features	Blade rotation	Motorized rotation Manual rotation dial
	Replaceable parts	Blade
		Clamp arm

## CT50 Options

Item	Model	Remark
Fiber Setting Plate	AD-50	Optional fiber setting plate
Blade	CB-08	Blade for replacement
Clamp Arm	ARM-CT50-01	Clamp arm with anvil for replacement
Fiber Scrap Collector	FDB-05	Spare scrap collector
Side cover	SC-CT50-01	Side cover instead of scrap collector
Spacer	SPA-CT08-10	Cleave length 10mm
	SPA-CT08-09	Cleave length 9mm
	SPA-CT08-08	Cleave length 8mm

### Notes

- \*1 When the cleave length is less than 10mm, the coating diameter should be 250µm or less. Also, a blade height adjustment is required before cleaving. The average cleave angle is worse than the specification when the cleave length is less than 10mm.
- \*2 Measured with an interferometer at room temperature, not with a splicer. A new blade was used to cleave both the single fibers and ribbon fibers. The average cleave angle changes depending on the environmental conditions, blade condition, operating method, and cleanliness.
- \*3 The blade life changes depending on the environmental conditions, operating method, and the fiber type cleaved.
- \*4 Measured in a condition when closing the lever
- \*5 Bluetooth® mark and logos are the registered trademarks of Bluetooth SIG, Inc.

## RS03 Specifications



Item		Specification
Applicable fiber	Fiber type	Single mode optical fiber
		Multi mode optical fiber
	Fiber count	Up to 16 fiber ribbon
	Cladding dia.	Approx. 125µm
	Coating dia.	200 to 400µm
Stripping length		Max. 35mm
Heat time *1		Approx. 3sec
Heat temperature		Approx. 5sec with Eco-mode 85 to 140 degreeC
Physical description	Dimensions W	Approx. 156mm without projection
	Dimensions D	Approx. 49mm without projection
	Dimensions H	Approx. 37mm without projection
	Weight	Approx. 265g including battery
Environmental condition	Temperature	Operate : -10 to 50 degreeC Storage : -40 to 80 degreeC
	Humidity	Operate : 0 to 95%RH non-condensing Storage : 0 to 95%RH non-condensing
AC adaptor	Input	AC100 to 240V, 50/60Hz, Max. 0.58A
DC input		DC10 to 17V, Approx. 1A
Battery pack	Type	Rechargeable Lithium Ion
	Output	Approx. DC7.2V, 1840mAh
	Capacity *2	Approx. 600 times with Eco-mode
	Temperature	Operate : -10 to 50 degreeC Recharge : 0 to 40 degreeC Long Term Storage : -20 to 30 degreeC
	Battery life *3	Approx. 500 recharge cycles
Wireless interface *4		Bluetooth 4.1 LE
Other features	Stripping force	Lower stripping force design
	Automatic heat setting	Controlled from splicer or smartphone

## RS03 Options

Item	Model Name	Remark
Spacer	SPA-RS02-08	Coating length 8mm
DC power cord	DCC-11	Splicer to ribbon stripper

### Notes

- \*1 Measured at room temperature. The heat time changes depending on the environmental conditions and fiber coating type.
- \*2 Tested at room temperature with a not degraded battery and Eco-mode. The number of cycles changes depending on the environmental conditions, stripper settings and battery degrading condition.
- \*3 The battery capacity decreases to a half after approx. 500 discharge and recharge cycles. The battery life is shortened further when using outside of the storage temperature range, operating temperature range, if completely discharged by storing for a long time without recharging.
- \*4 Bluetooth® mark and logos are the registered trademarks of Bluetooth SIG, Inc.

Replaceable V-groove  
System

Please visit our web site!

<https://www.fusionsplicer.fujikura.com>



Enhanced splice  
quality

Smart & Secure  
management

**BEST QUALITY  
SERVICE**

- SINCE 1978 -

## Fujikura Ltd.

1-5-1, Kiba, Koto-ku, Tokyo 135-8512, Japan  
General inquiries : +81-3-5606-1164 Service & support : +81-43-484-3962

<https://www.fujikura.com>

## Fujikura Asia Ltd.

438A Alexandra Road, Block A Alexandra Technopark #08-03 Singapore 119967  
General inquiries, Service & support : +65-6-278-8955

<https://www.fujikura.com.sg>

## Fujikura Europe Ltd.

C51 Barwell Business Park, Leatherhead Road, Chessington, Surrey, KT9 2NY, UK  
General inquiries : +44-20-8240-2000 Service & support : +44-20-8240-2020

<https://www.fujikura.co.uk>

## AFL

260, Parkway East, Duncan, SC29334, USA  
General inquiries : +1-800-235-3423 Service & support : +1-800-866-3602

<https://www.aflglobal.com>

## Fujikura (China) Co., Ltd.

7th Floor, Shanghai Hang Seng Bank Tower, 1000 Lujiazui Ring Road, Pudong New Area, Shanghai 200120, CHINA  
General inquiries, service & support : +86-21-6841-3636

<http://www.fujikura.com.cn>